

Microfluidic device example

Mode navigator for fluid dynamic model- Navier Stokes equation

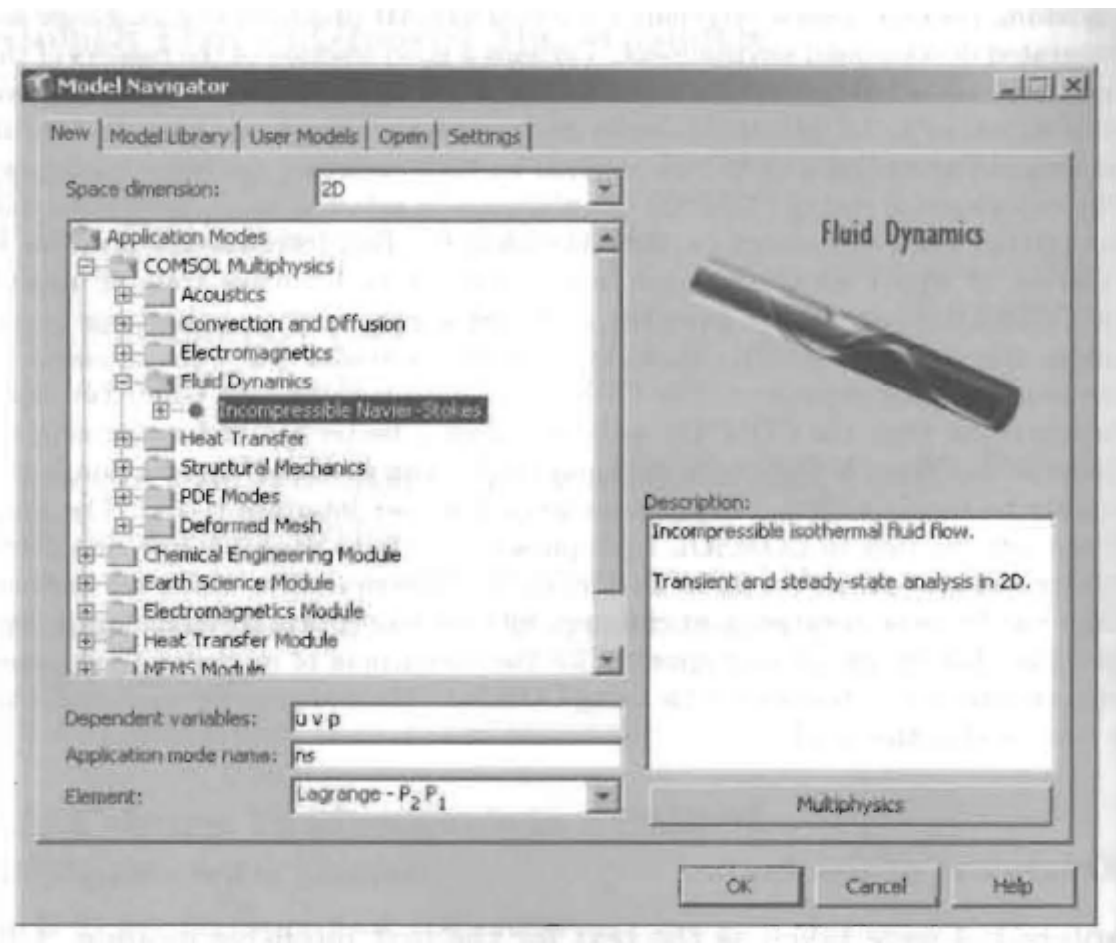

2D Model for microchannel fluid motion

Figure 1. The pre-built application modes are arranged in a tree structure on the Model Navigator. Here is the Incompressible Navier-Stokes mode under the Chemical Engineering Module. The Model Navigator specifies that this mode is 2-D, has three dependent variables, and uses a mixed type of element Lagrange p_2 for the velocities u and v , Lagrange p_1 for the pressure. Using mixed order discretization schemes is quite common in finite element methods for numerical stability of the Navier-Stokes solvers. The SIMPLE scheme [1] pioneered the approach. The Model Navigator allows the user to specify pre-built application modes or to customize a generic PDE mode (coefficient, general, weak) to build up their own model.

Model library-Microfluidics

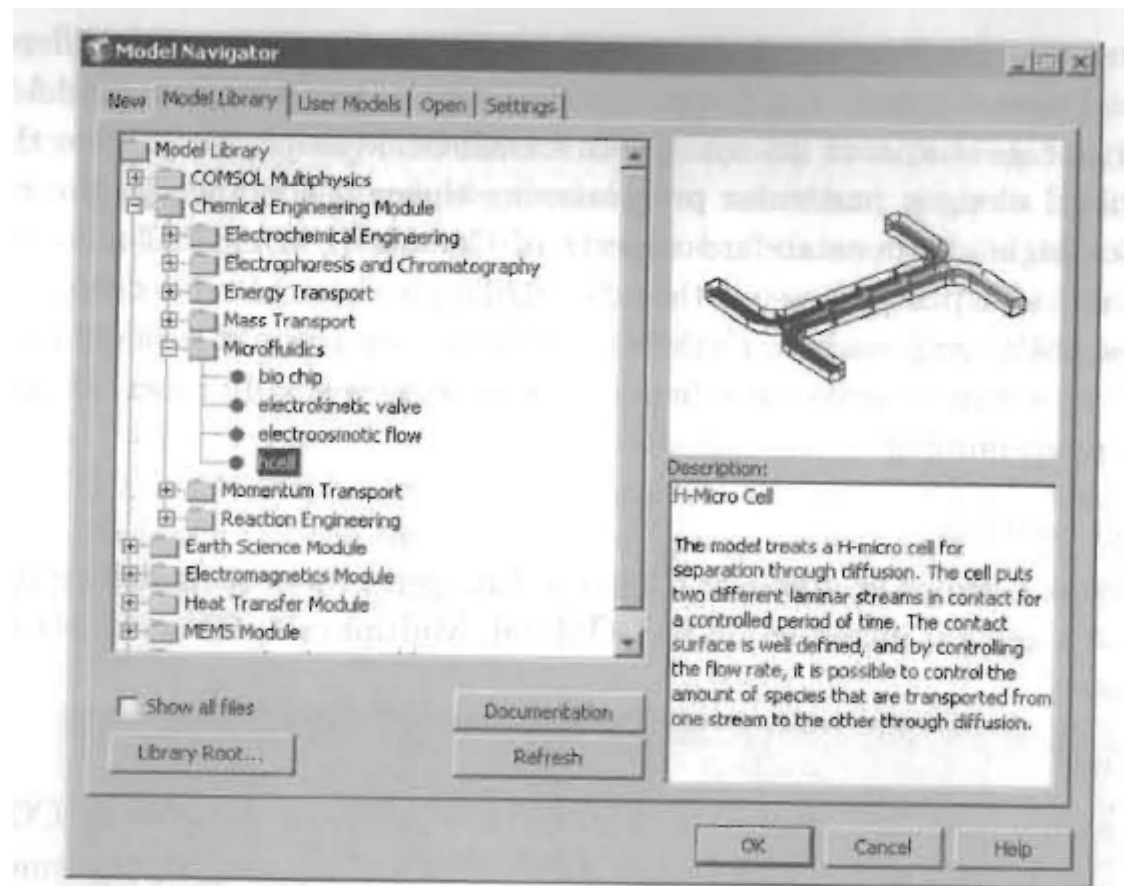

Solved microfluidic H-cell

Figure 2. The Model Library contains already solved problems using existing application modes. The Model Library includes models created by COMSOL staff and donated by users. The growth in the content of the Model Library over the last twelve months has been phenomenal. Browsing the COMSOL Multiphysics models and the Model Library documentation of them is an excellent way of generating modeling ideas. The Model Library is organized by subject matter. Here, the microfluidic H-cell is highlighted, under the tree structure with branch Chemical Engineering Module and sub-branch Microfluidics. Microfluidics and MEMs are a frequent subject matter for multiphysics simulation

Postprocessing screen

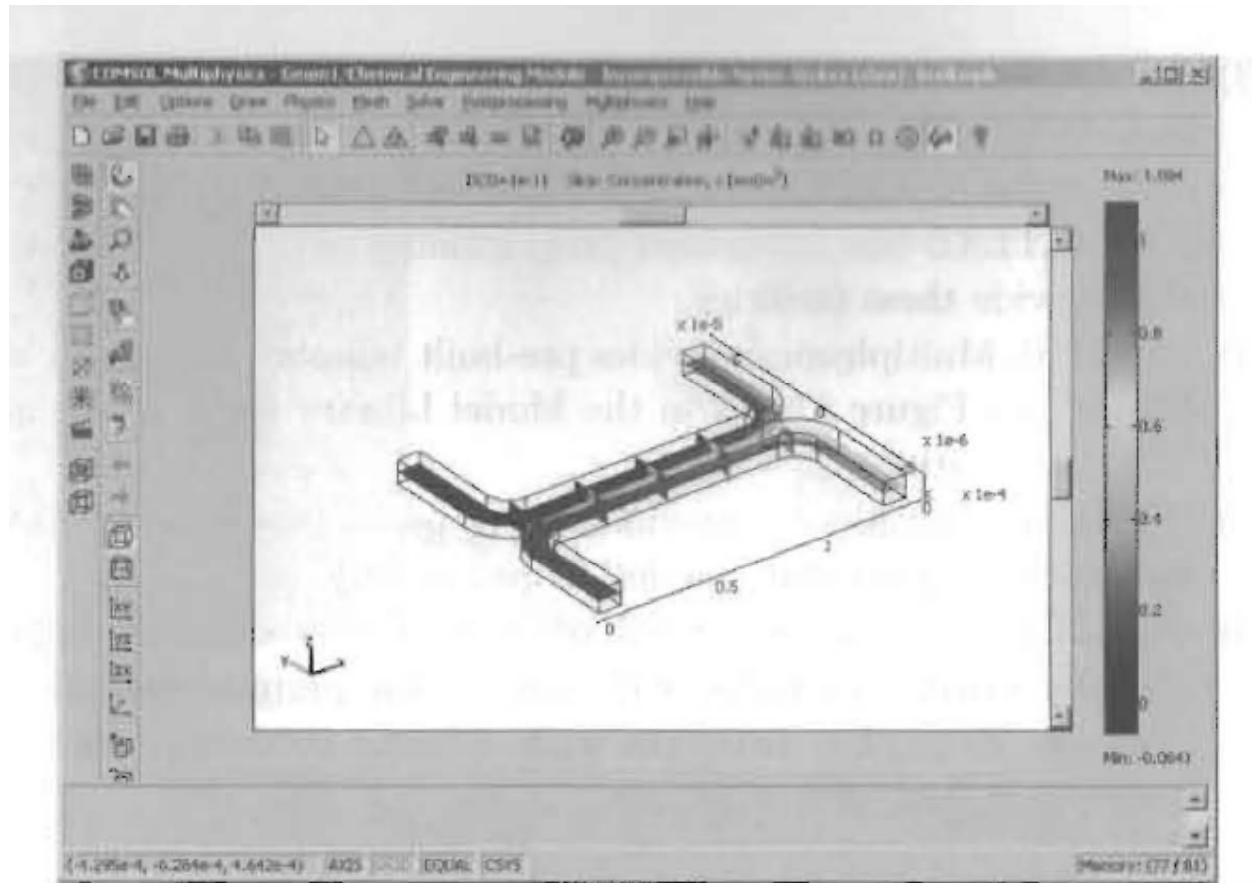

Geometry, meshing, PDE eqns, BC's and postprocessing solution

Figure 3. COMSOL Multiphysics' postprocessing screen. Here the solution for the last executed run of the microfluidic H-cell model is shown. COMSOL Multiphysics' GUI provides pull down menus and toolbars to initiate all building blocks of model construction — specifying analyzed geometries, meshing, specifying PDE equations and boundary conditions, analyzing and post processing the solutions found. Note that the status bar at the bottom shows the position of the cursor on the visualization window. The information window just above it echoes messages to the screen from the COMSOL/MATLAB commands executed in COMSOL Multiphysics' MATLAB workspace. The "Loading data from static_mixer.mat" message was the response to our request to load the model library entry for the turbulent static mixer.

Option menu

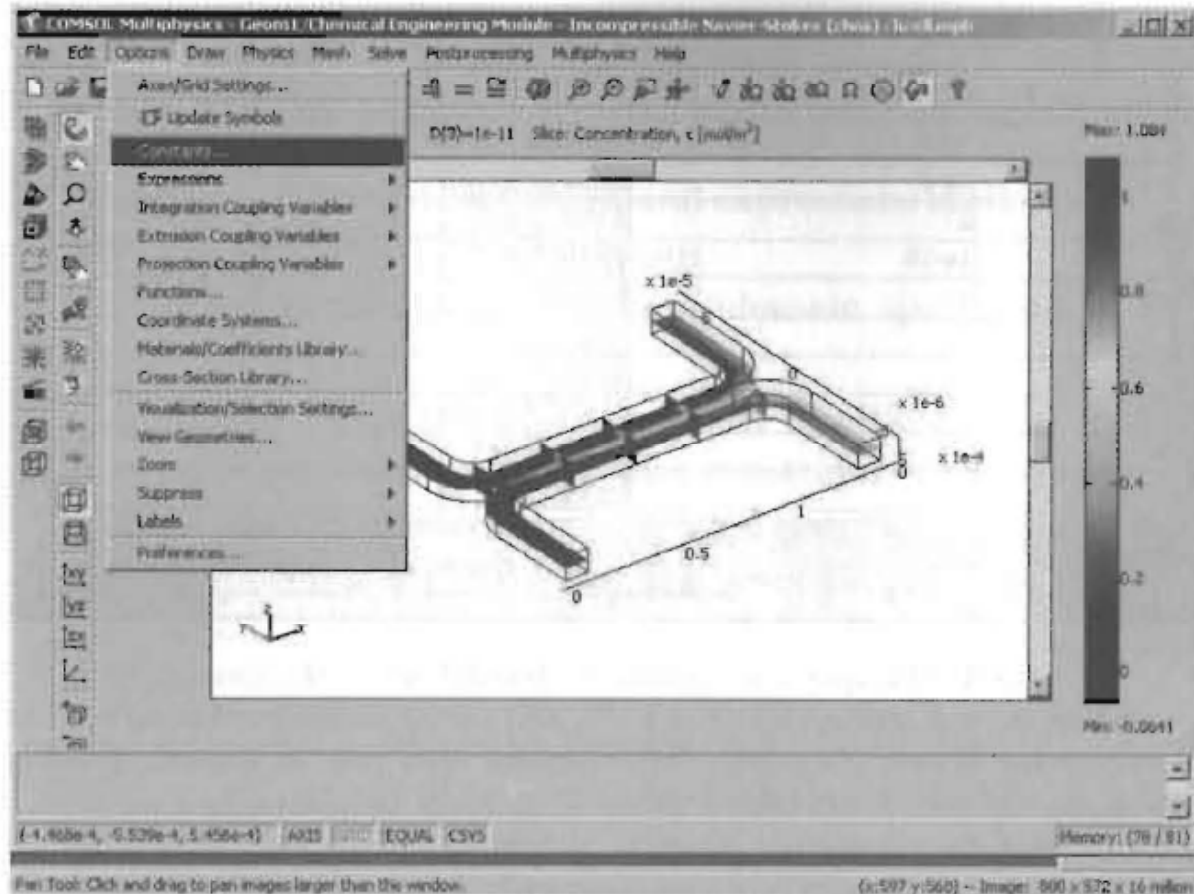
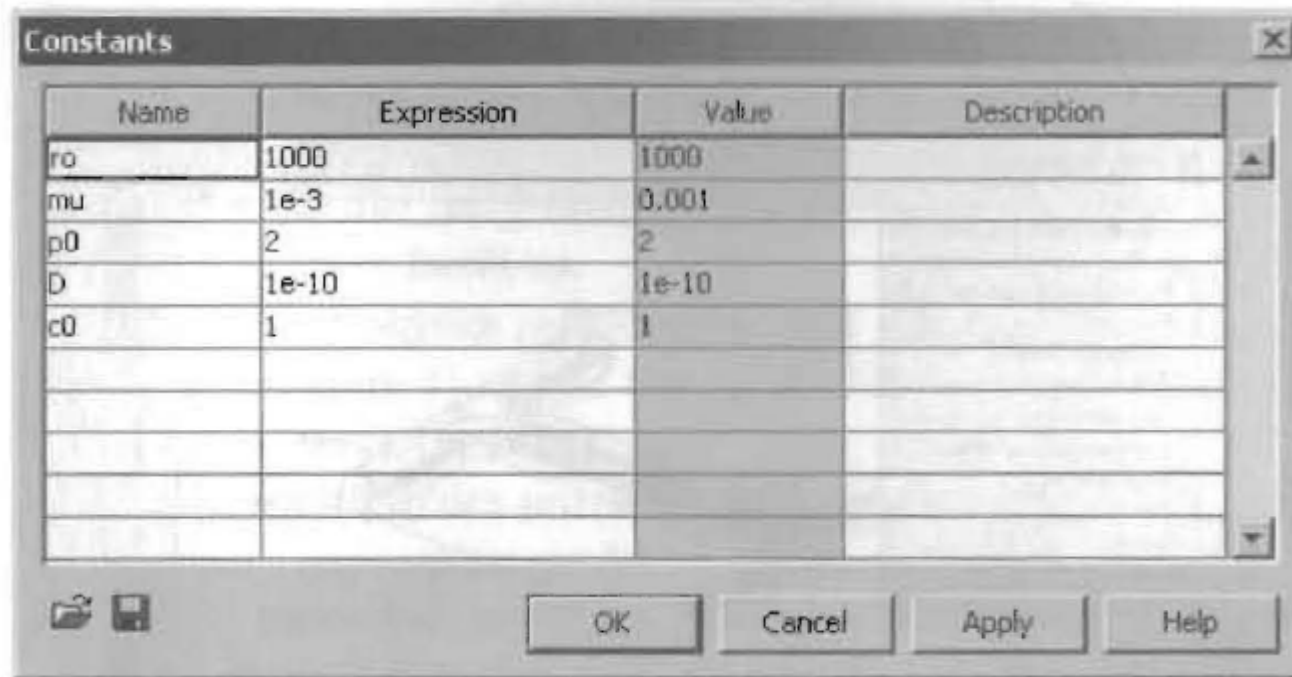

Figure 4. The Options Menu permits definition of many useful feature: constants, grids for drawing and visualization, and expressions used in entering the model equations are its most common uses.

Constants



Name	Expression	Value	Description
ρ_0	1000	1000	
μ	1e-3	0.001	
p_0	2	2	
D	1e-10	1e-10	
c_0	1	1	

Figure 5. COMSOL Multiphysics constants (density $\rho_0 = 100$, viscosity $\mu = 10^{-3}$, pressure datum $p_0 = 2$, diffusivity $D = 1^{-10}$, and initial concentration $c_0 = 1$) defined for the microfluidic H-cell. COMSOL Multiphysics does not, in general, presume any unit system, so the user is advised to enter all physical properties as constants. Some application modes have materials property databases, which have pre-assigned units. The onus is on the user to make sure that their units are consistent in mixing pre-defined application modes with user-defined equation application modes.

Draw menu

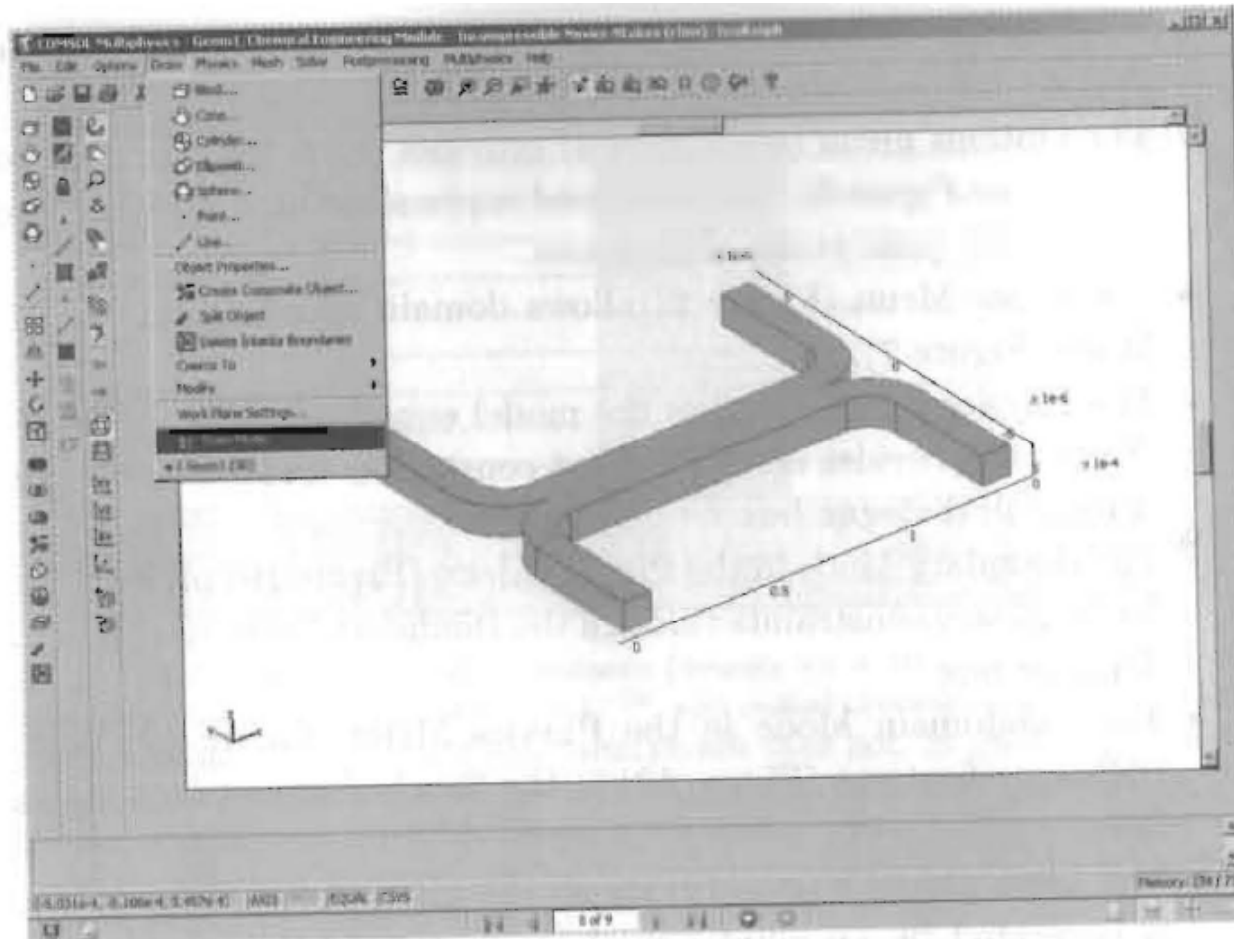

Figure 6. Draw Mode is selected from the Draw Menu.

Geometry commands

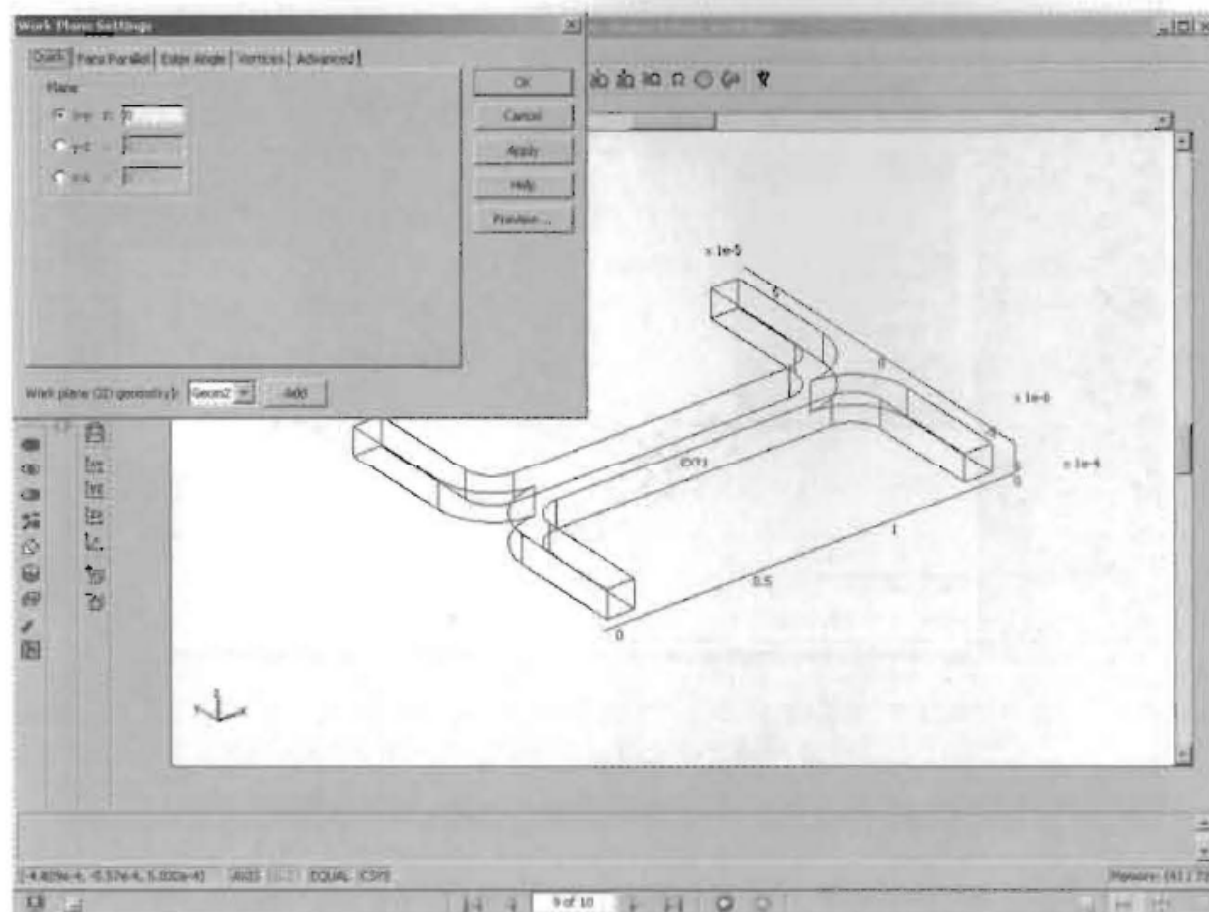

Figure 7. The single composite analyzed geometry (EXT1) of microfluidic H-cell. This geometry was drawn by geometry primitive commands (rectangles and arcs) and then merged together to form one contiguous domain in a 2-D work plane. Then it was extruded in the depth dimension to form a 3-D geometry.

Points menu

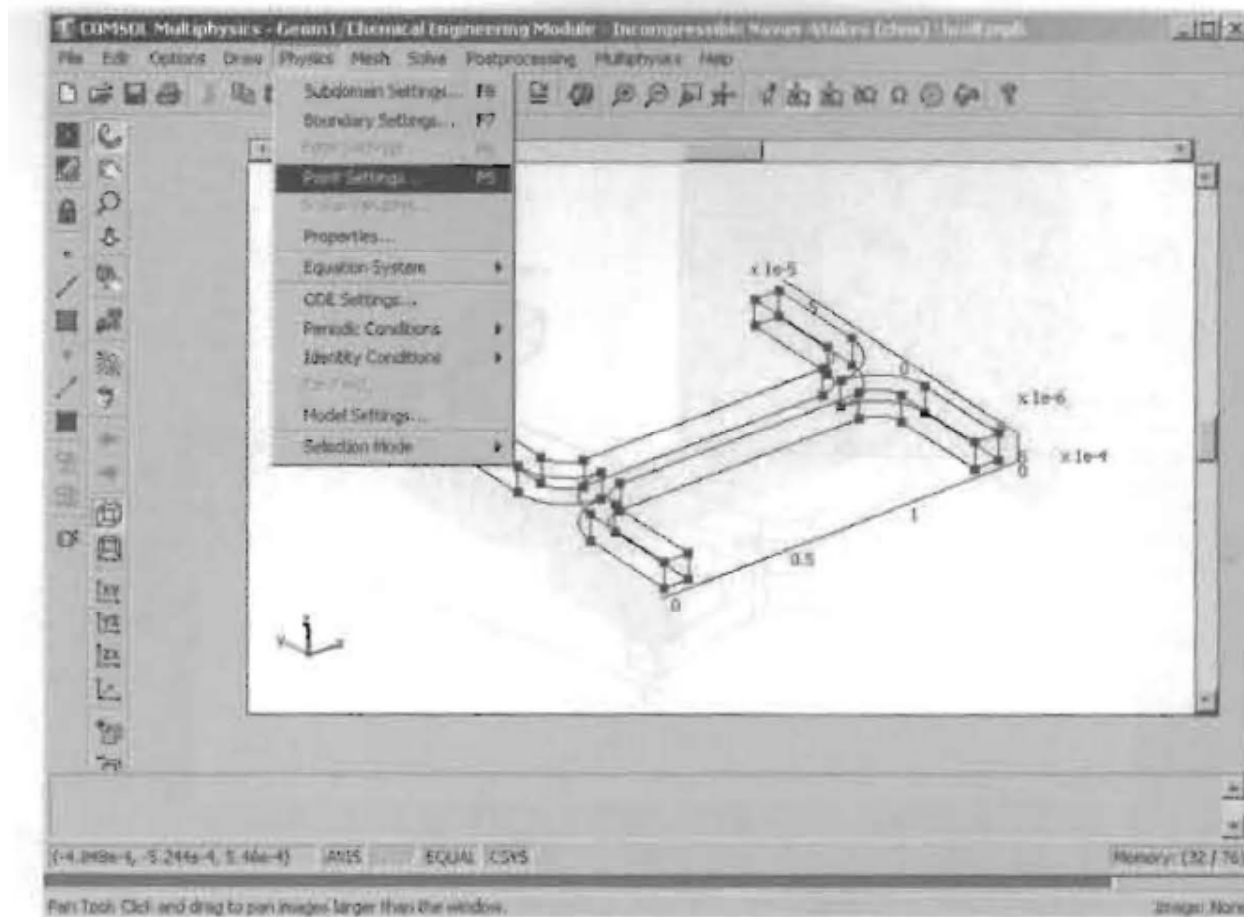

Figure 8. Point mode shows all the points (vertices and specifically identified points) distinguished in the geometry model by black cubes.

Points setting

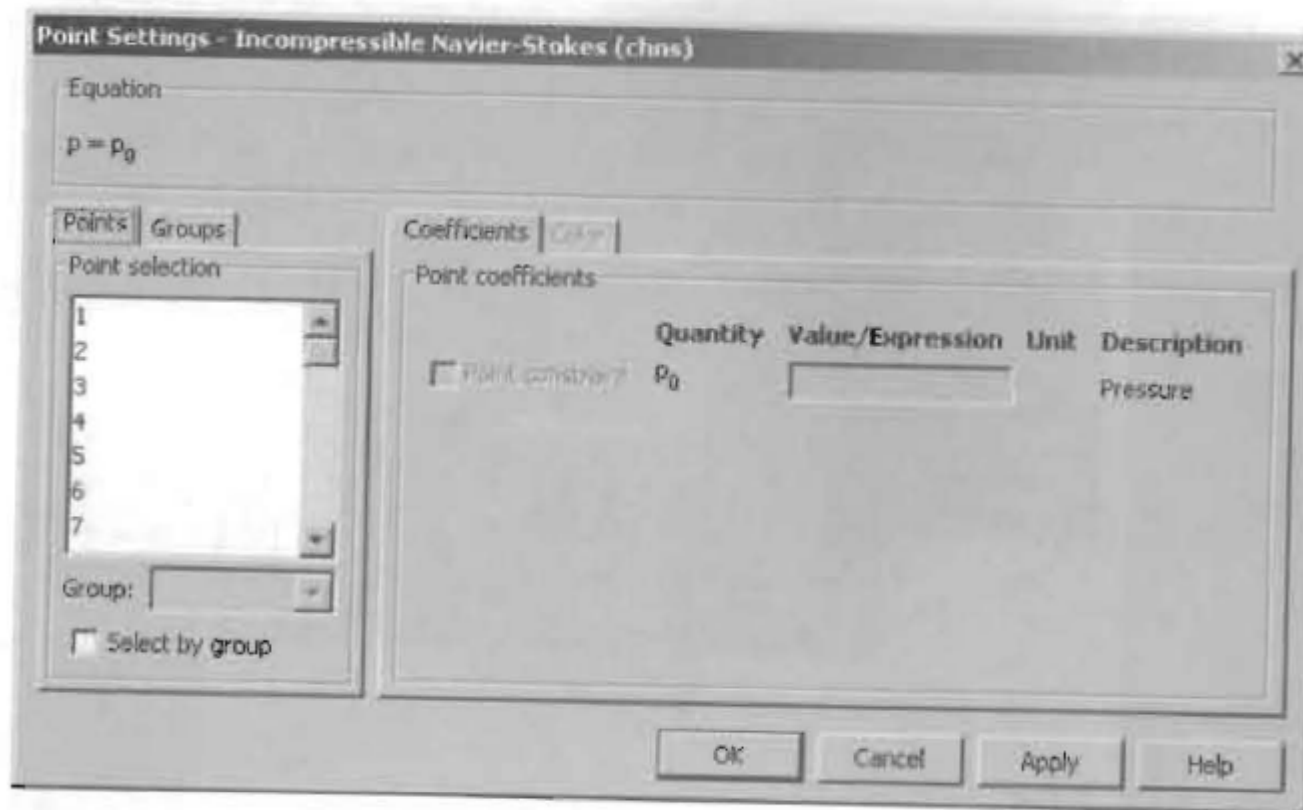

Figure 9. Point settings dialogue box. In the Incompressible Navier-Stokes Mode, only the pressure datum can be directly set in point settings.

Summary

- Comsol multiphysics has a powerful GUI that provides easy entry to try out “What if” scenarios and explore modelling methods without programming.
- It has unique modelling advantages in multiphysics and extended multiphysics.

- COMSOL Multiphysics provides a method of automatically creating MATLAB m-file code that reduces the programming effort for setting up more complicated models.
- Exporting solutions to MATLAB also makes post solution analysis more flexible.
- COMSOL Multiphysics/MATLAB provides automation opportunities, including running efficiently as a background job.