

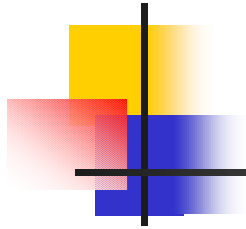

2001.12.13.

3



()

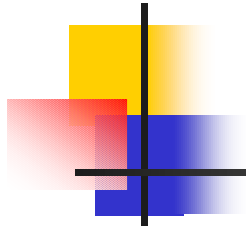

:



가



/

:

/

/

/

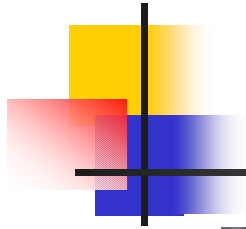

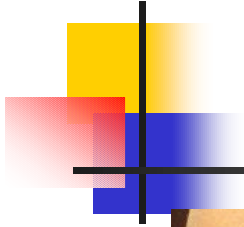

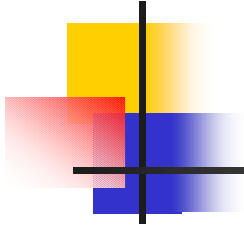

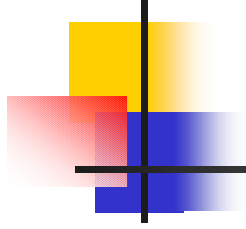

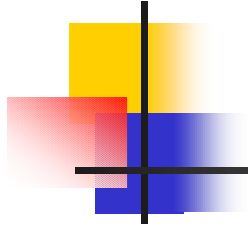

가

-
-
-
-

,

()

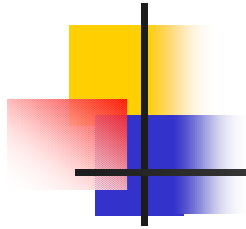

:

가

,

가

가

가

3 가

.



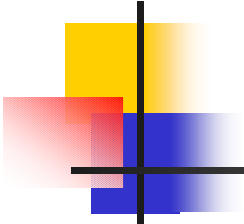

(1)



/

✓ 多 狹

✓ A,B,C, D



(2)

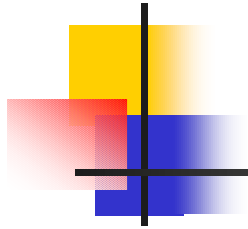

■

,

■

,

■

■ 33

가

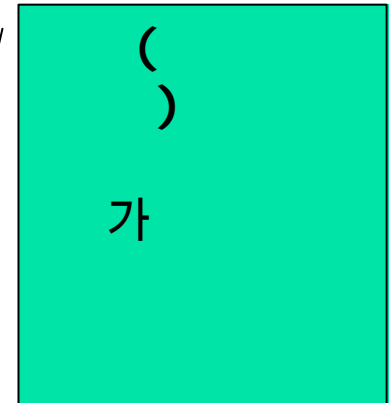

가

■

가

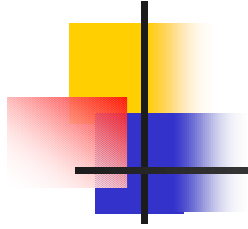

(1)

:

(2)

:

가

가

(3)

:

,

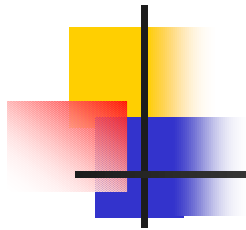

■ A

B

C

,

C

D

E

, E

F

G

G

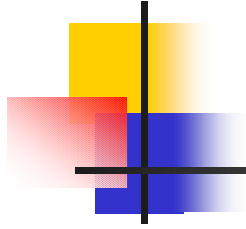

(1) A B C
(2) C D E
(3) E F G

3

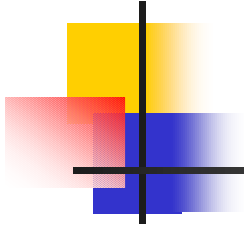

A

B

C

,

(1)

X

(2)

D

(3)

100 ~ 200oC,

50 ~ 70

C

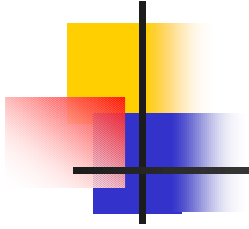

(1)

(2)

(3)

(4)

(5)

(6)



000 (X)

(O)
(X)

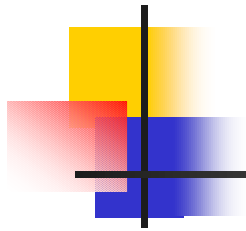

()



Best Mode 가



/



/ () / /



:

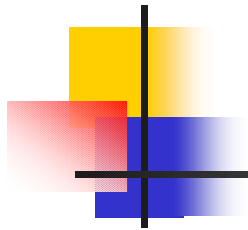

2 /

■

■

■

■

가 ()

=?

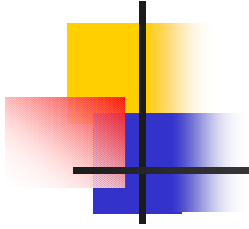

-
-
- ✓
- ✓
- ✓
-
- ✓
- ✓
- ✓
-

42

,

가
가

- - -

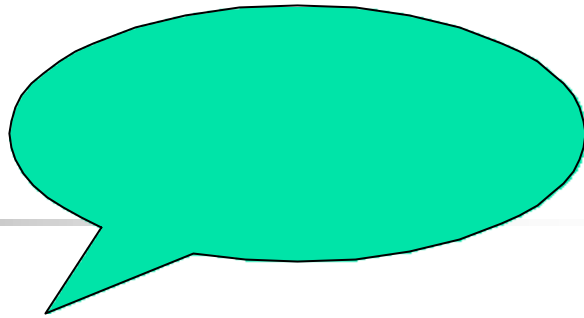
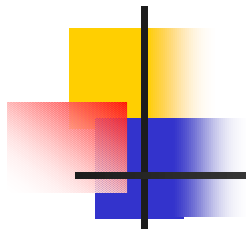

, ,
가

1. 40 ~ 90% , 10 ~ 50%
, 5 ~ 10%

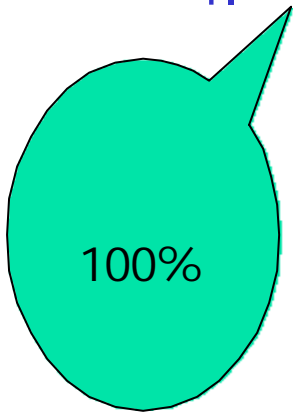

1 , 가 가

(1)



:



(x)



(x)



,

(a)

(b)

(c)

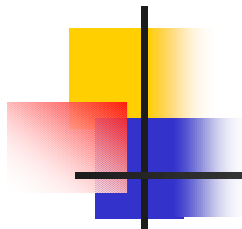

(a), (b), (c)

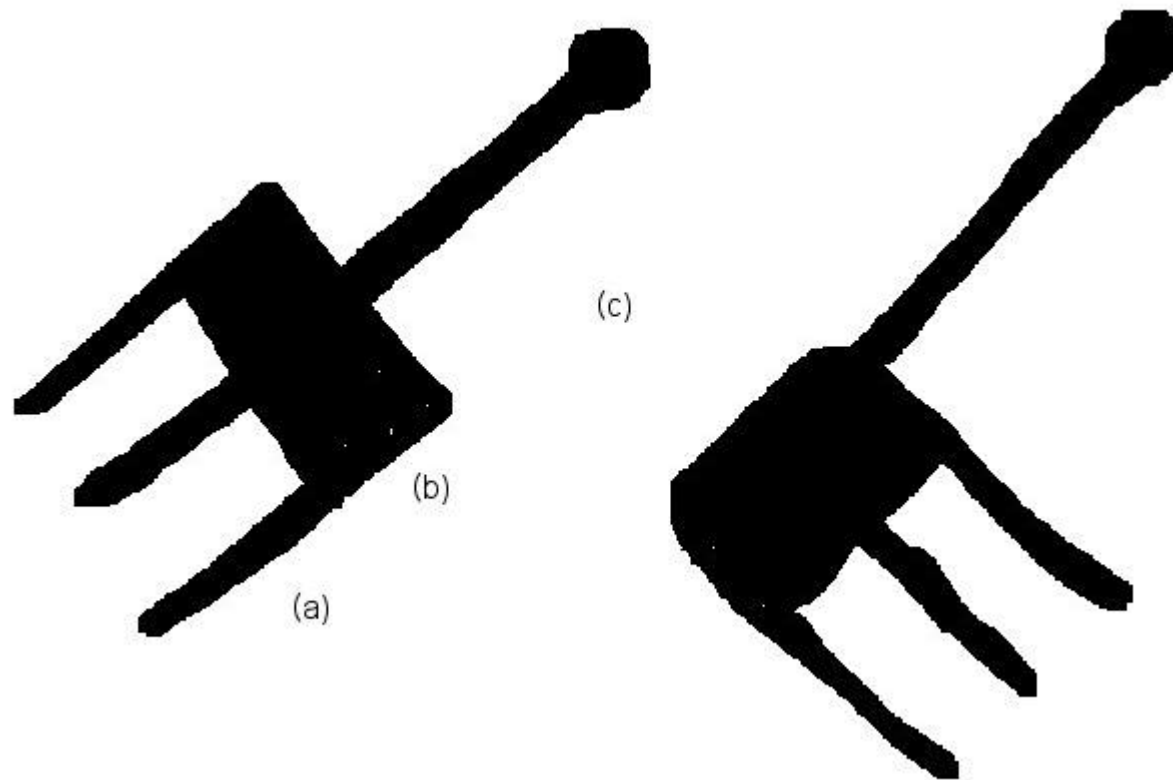

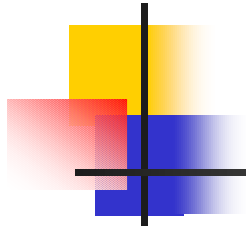

(a)

(b)

(c)

(d)

가

(2)





(a) (b) (c) (d) (e)

2. 1 ,

3. 1 ,

4. 3 ,

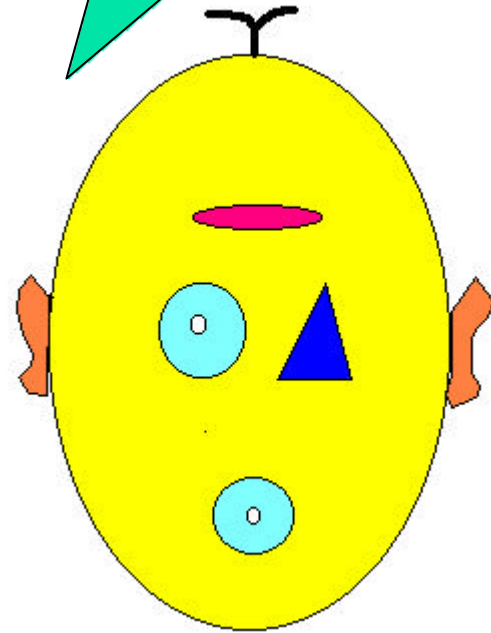
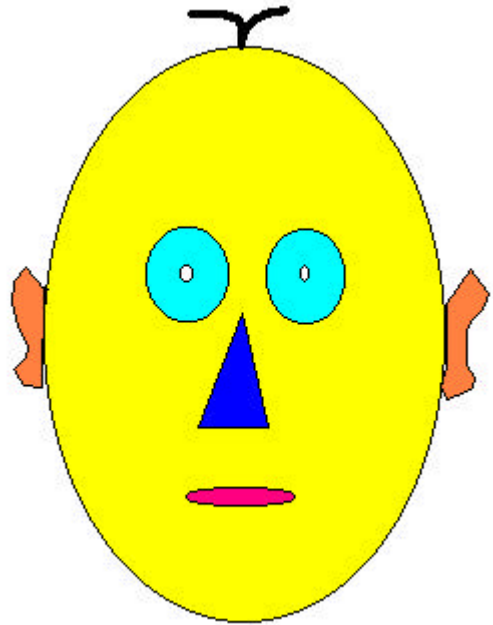
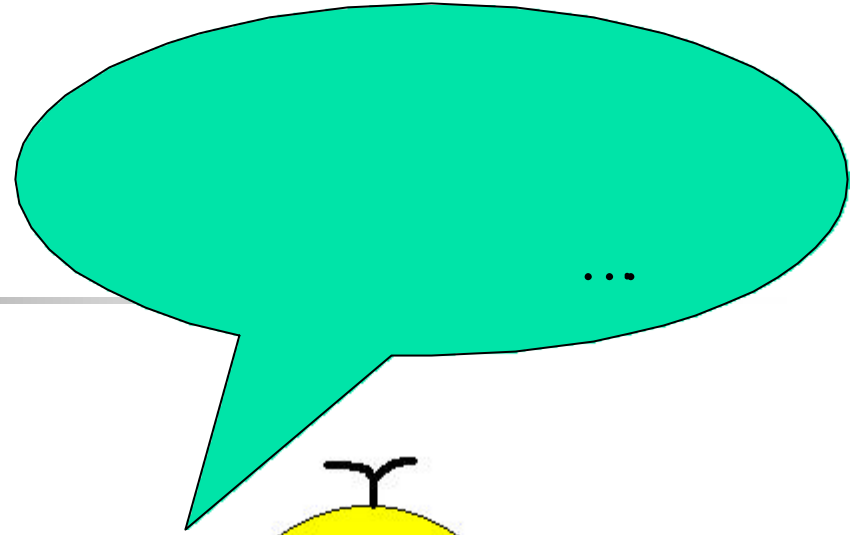
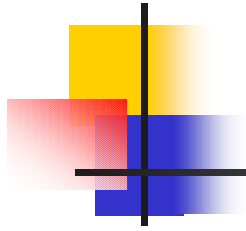

(2)



6. 1 ,

7. 6 ,

8. 1 , 가

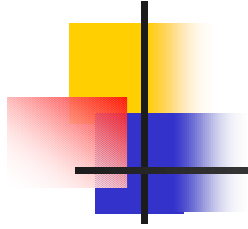

- :
- :

()



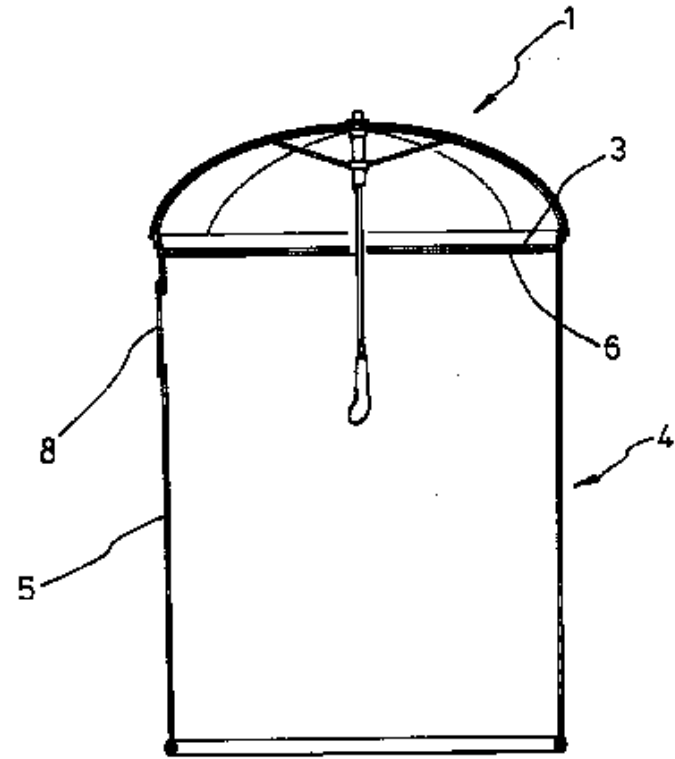
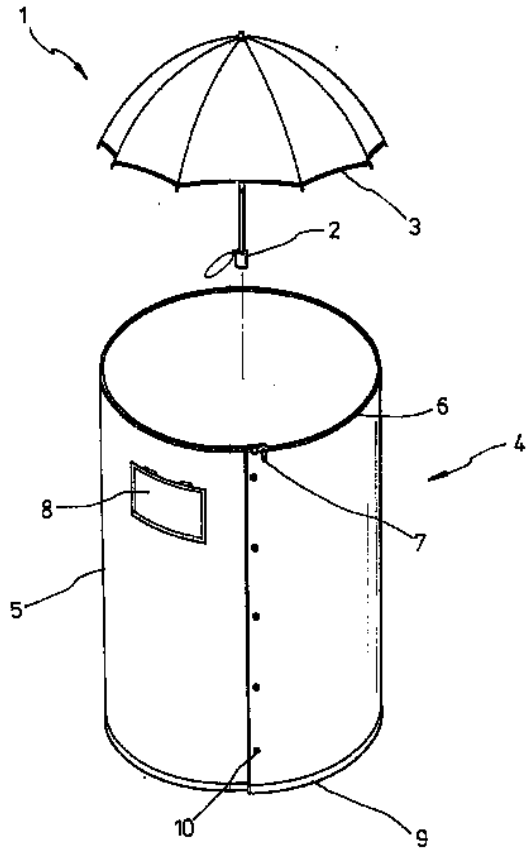
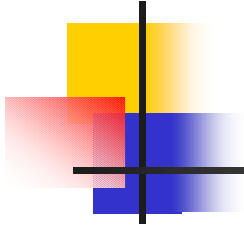

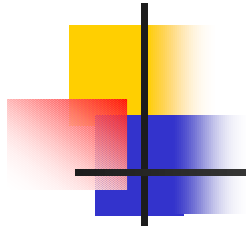

■

-

■

:

(1)

가

(3)

(4)

(5)

가

(7)가

(6)

(8)

(9)

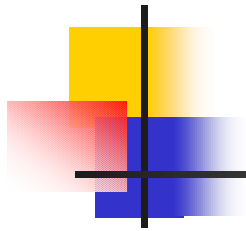

1.

:

2.

3.

4.

:

5.

:

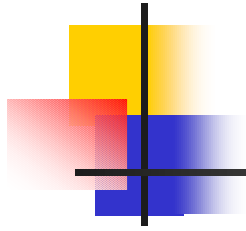

■ :
■ / / 가 / / -

