

---

# Methanol-DMC 이성분계의 기액 상평형 실험 및 압력변환 증류공정에 대한 공정 최적화 연구

2013년 9월 27일(금)

조재숙, 김동선, 조정호, 고재천<sup>†</sup>, 백준현<sup>†</sup>  
공주대학교, <sup>†</sup> 포항산업과학연구원(RIST)

---

# 서론 : Pressure-Swing Distillation의 원리

## < 압력변환 증류공정의 원리 >

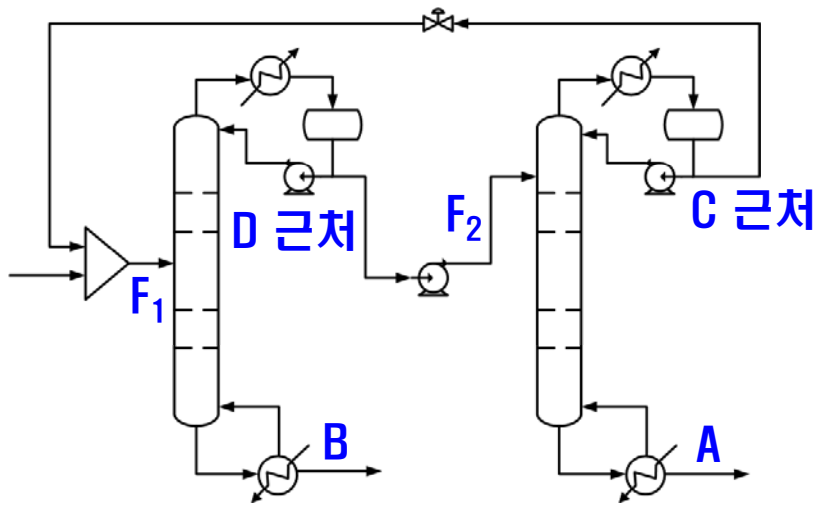

### 각 Point의 정의

- A : 고순도 DMC
- B : 고순도 Methanol
- C : 고압에서의 공비 조성
- D : 저압에서의 공비 조성
- F<sub>1</sub> : LP Column의 Feed 조성
- F<sub>2</sub> : HP Column의 Feed 조성

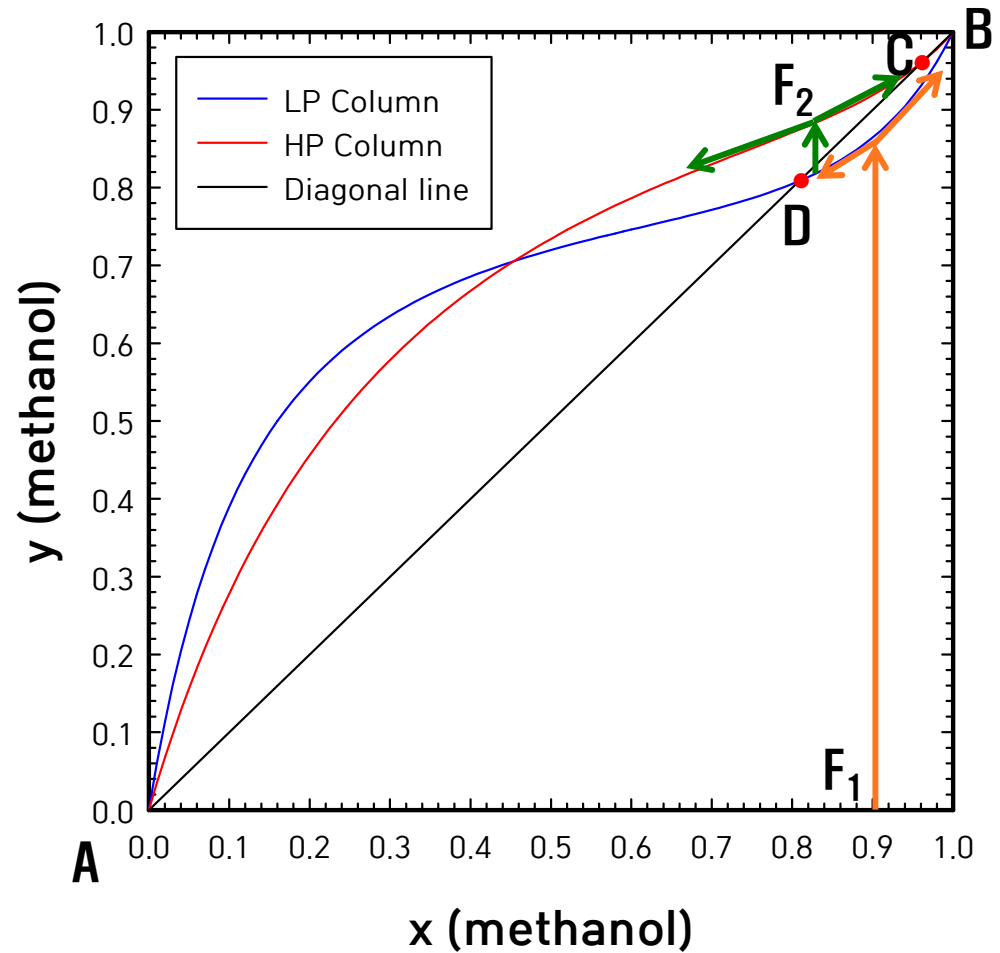

# 서론 : 기액 상평형 실험의 필요성

MeOH-DMC 계의 Txy 선도 at P=30 kPa

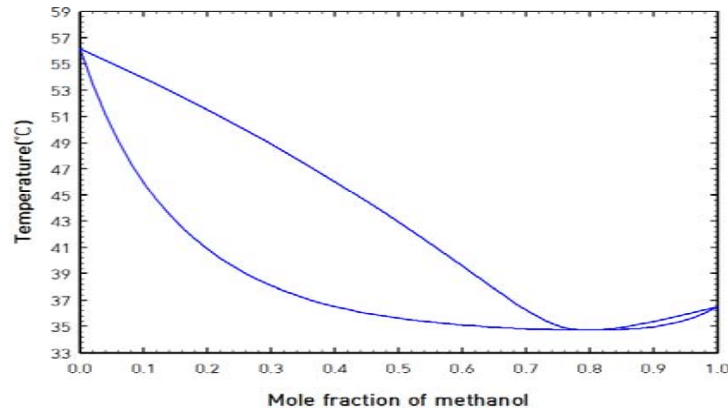

ChemCAD v6.3.1

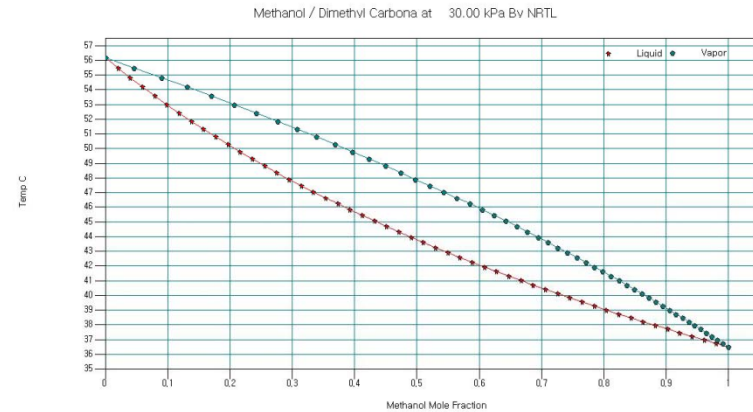

PRO/II with PROVISION 9.1

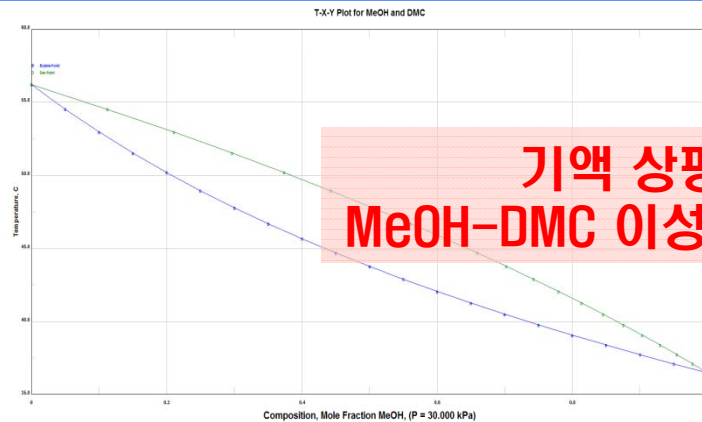

Aspen Plus v7.3

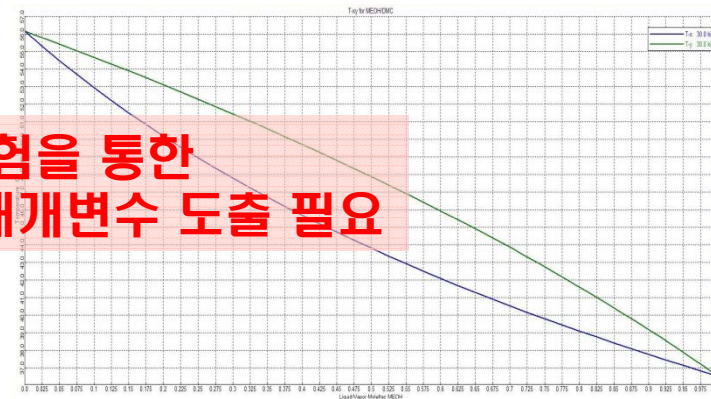

기액 상평형 실험을 통한  
MeOH-DMC 이성분계 매개변수 도출 필요

# 기액 상평형 실험 - 방법

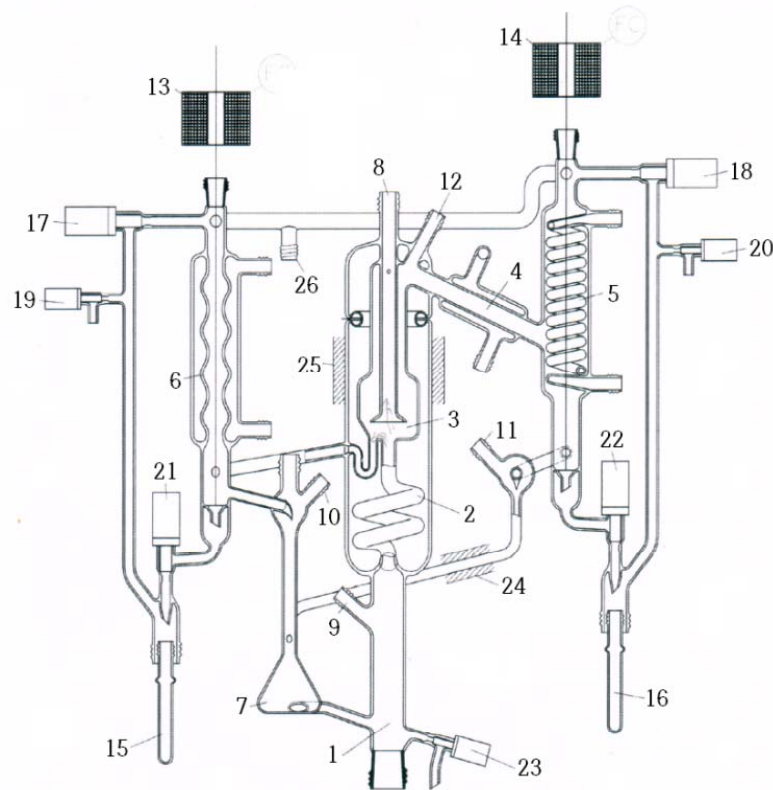

Fischer사의 기-액 상평형 실험 장비

## < 기-액 상평형 실험 방법 >

기-액 상평형 실험 전 표준시료 제조를 통한  
검량선 작성

순수 성분의 끓는점 측정을 이용한  
기-액 상평형 실험 장치 검증

상압(1013 mbar) 및 저압(300 mbar) 조건에서  
기-액 상평형 실험 수행

기-액 상평형 실험 결과를 정리하여  
TXY 및 XY Plot 작성

# 기액 상평형 실험 - 표준시료 제조

## ➤ 표준시료 제조 (MeOH-DMC)

※ MeOH 순도 : 99.9 wt%, DMC 순도 : 99.5 wt%

wt%	MeOH 질량 (g)	DMC 질량 (g)	총 질량 (g)	MeOH 실제질량 (g)	MeOH 실제농도 (wt%)
0	0.00	20.00	20.00	0.000	0.000
10	2.01	17.99	20.00	2.008	10.040
20	4.00	15.99	19.99	3.996	19.990
30	6.00	14.00	20.00	5.994	29.970
40	8.00	12.00	20.00	7.992	39.960
50	10.00	10.00	20.00	9.990	49.950
60	12.01	7.99	20.00	11.998	59.990
70	14.00	6.01	20.01	13.986	69.895
80	16.00	4.00	20.00	15.984	79.920
90	18.00	2.00	20.00	17.982	89.910
100	20.00	0.00	20.00	19.960	99.800

# 기액 상평형 실험 - 검량선 작성

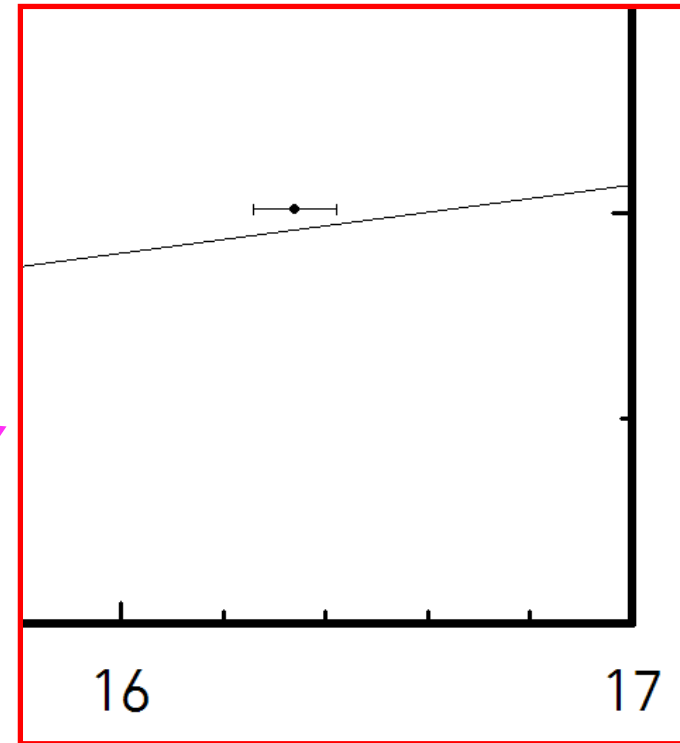
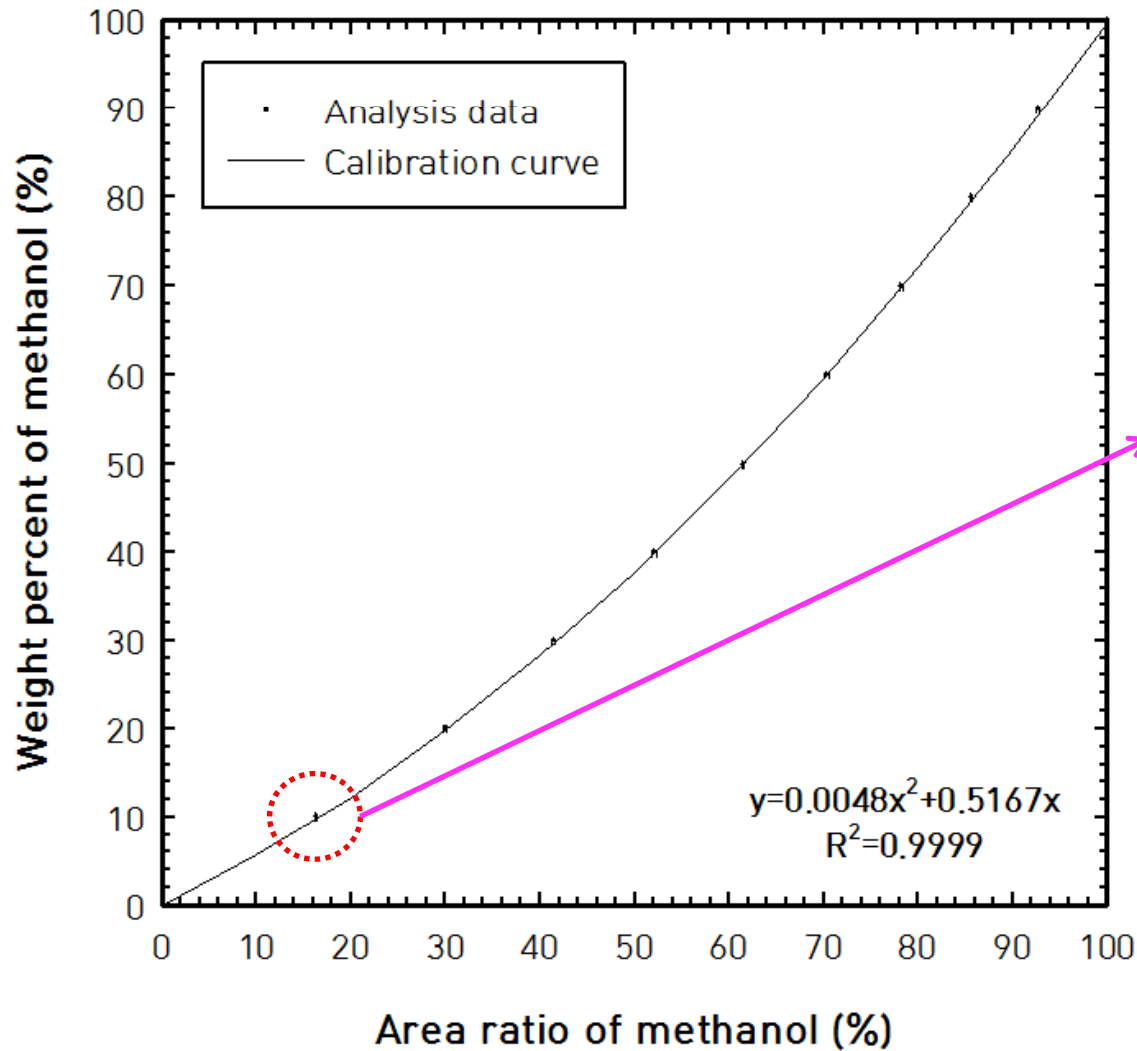

x1	x2	x3	y	SD
16.42	16.37	16.23	10.04	0.08

# 기액 상평형 실험 – MeOH-DMC 이성분계



메탄을 이용하여  
기-액 상평형 장치 세척

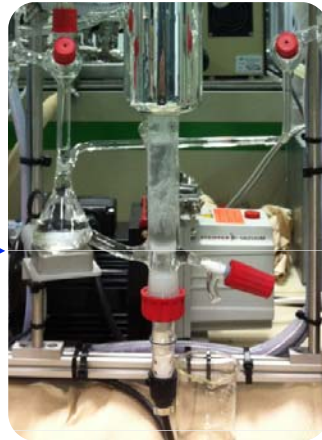

메탄올에 DMC를 조금씩  
가하면서 Sampling 수행



채취한 Sample의  
GC 정량분석 및 농도 확인

## 평형 도달 체크사항

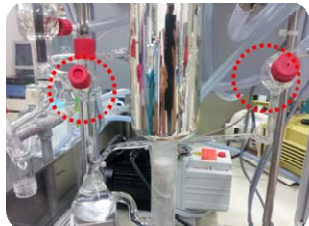

액상과 응축된 기상이  
일정하게 떨어짐



기상과 액상의 온도의  
시간에 따른 일정함



Control valve와 Control box를  
이용하여 설정한 압력

# 기액 상평형 실험 데이터 (상압 : 1 atm)

## 상압(1 atm)에서의 실험 수행

질소 가스를 이용하여 1 atm 압력을 구현한 후 실험을 수행  
Pressure Throttle valve를 이용하여 좀 더 세밀하게 압력을 조절함

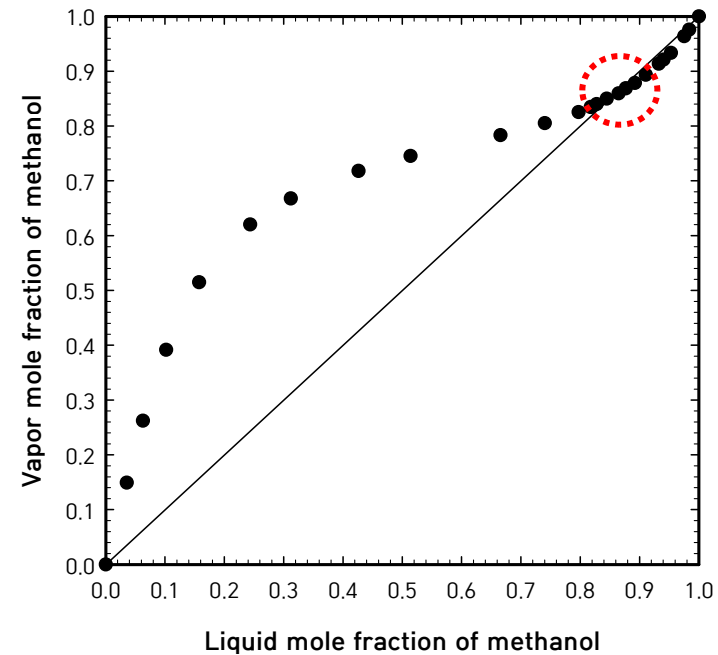
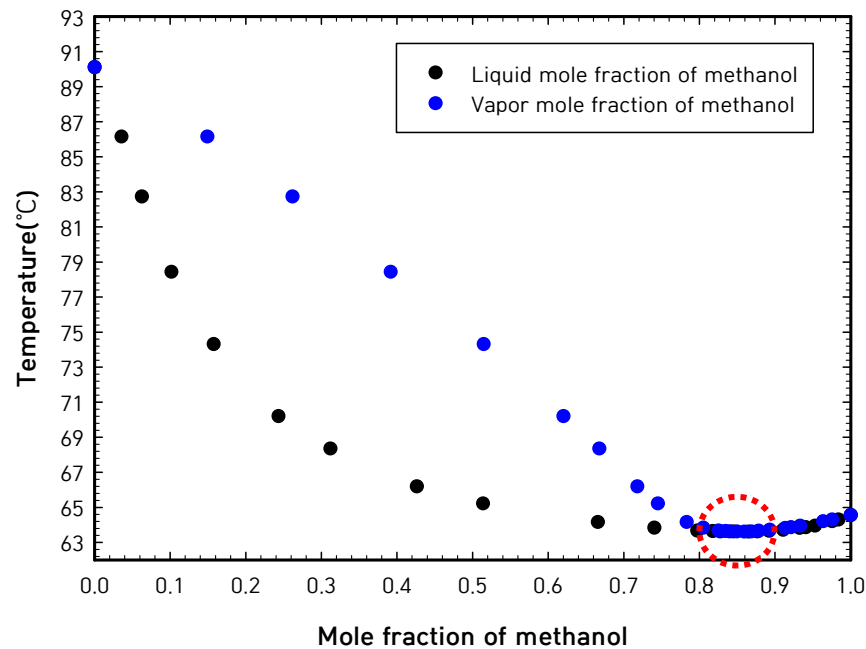



# 기액 상평형 실험 데이터 (저압 : 30 kPa)

## 저압(30 kPa)에서의 실험 수행

진공 펌프를 이용하여 30 kPa 압력을 구현한 후 실험을 수행  
 진공 펌프에 별도의 Valve를 설치하여 좀 더 세밀하게 압력을 조절함

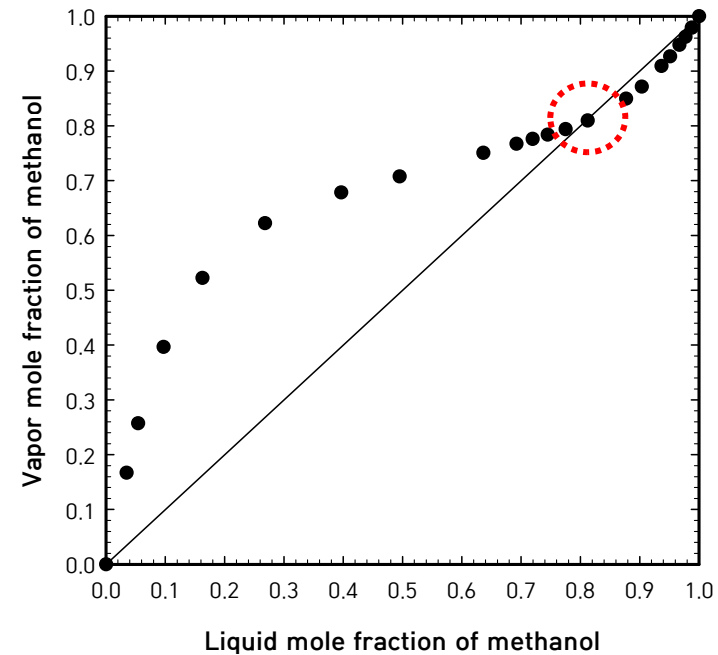
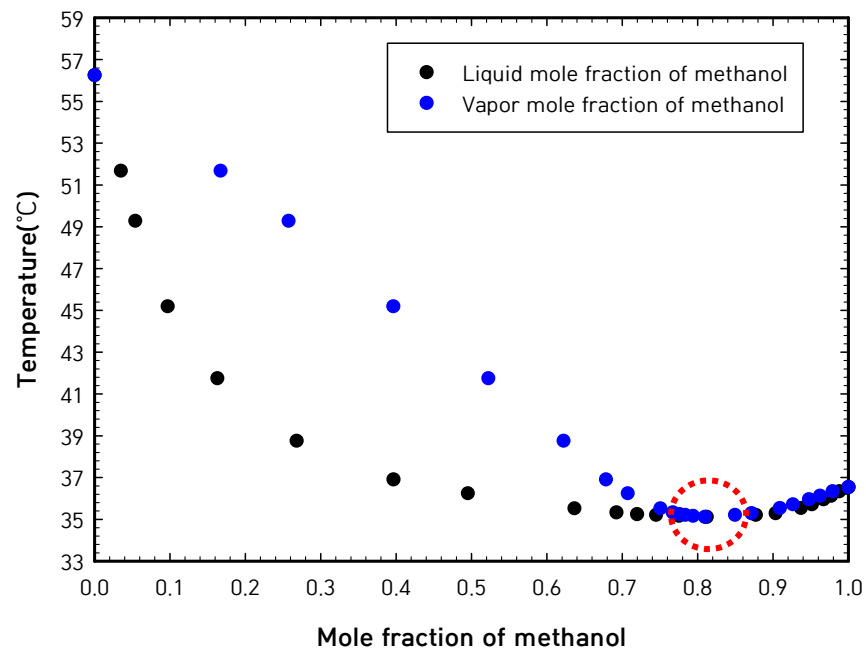

# 기액 상평형 실험 데이터 (고압 : 10 atm)

## 고압(10 atm)에서의 실험 데이터

RIST로부터 제공받은 논문(S.-J. Wang et al. 2010)에서  
고압 조건에서의 기액 상평형 실험 데이터 이용

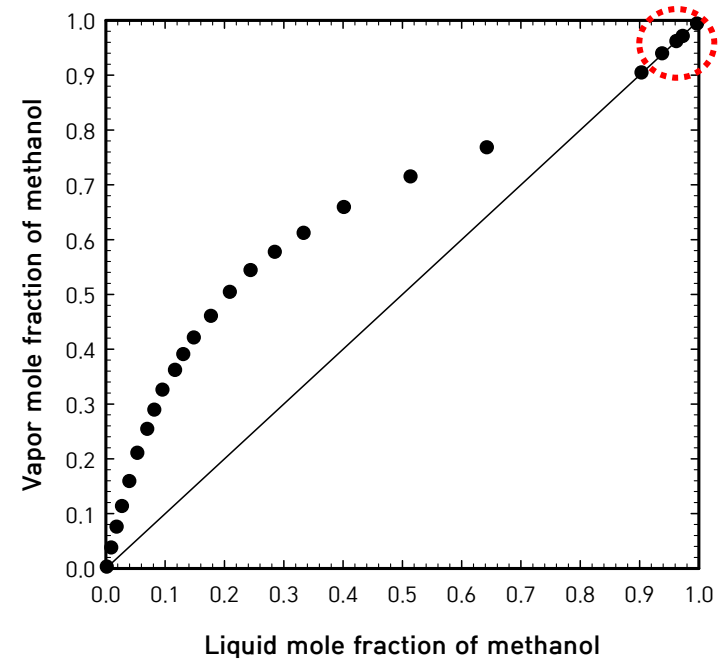
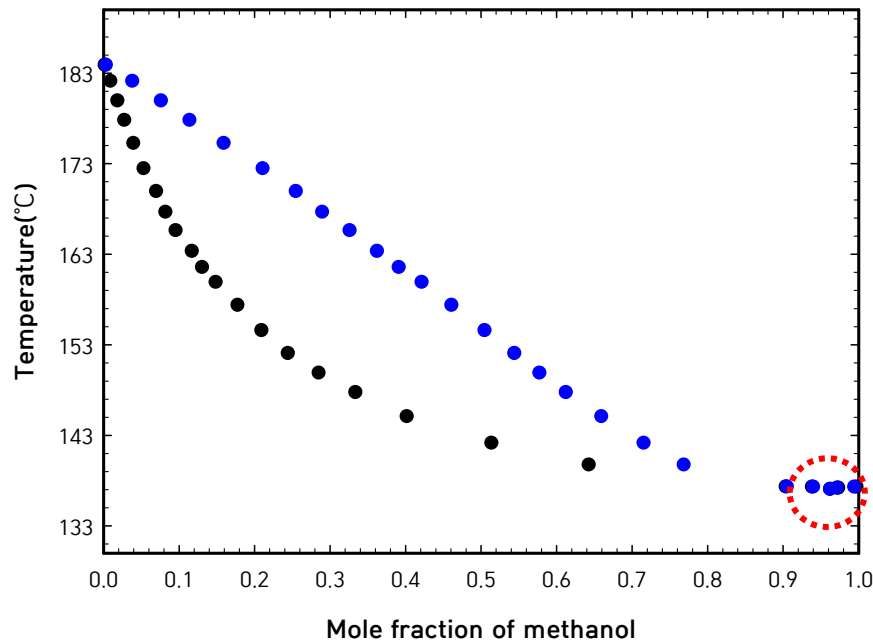

# NRTL Parameters regression (상압 : 1 atm)

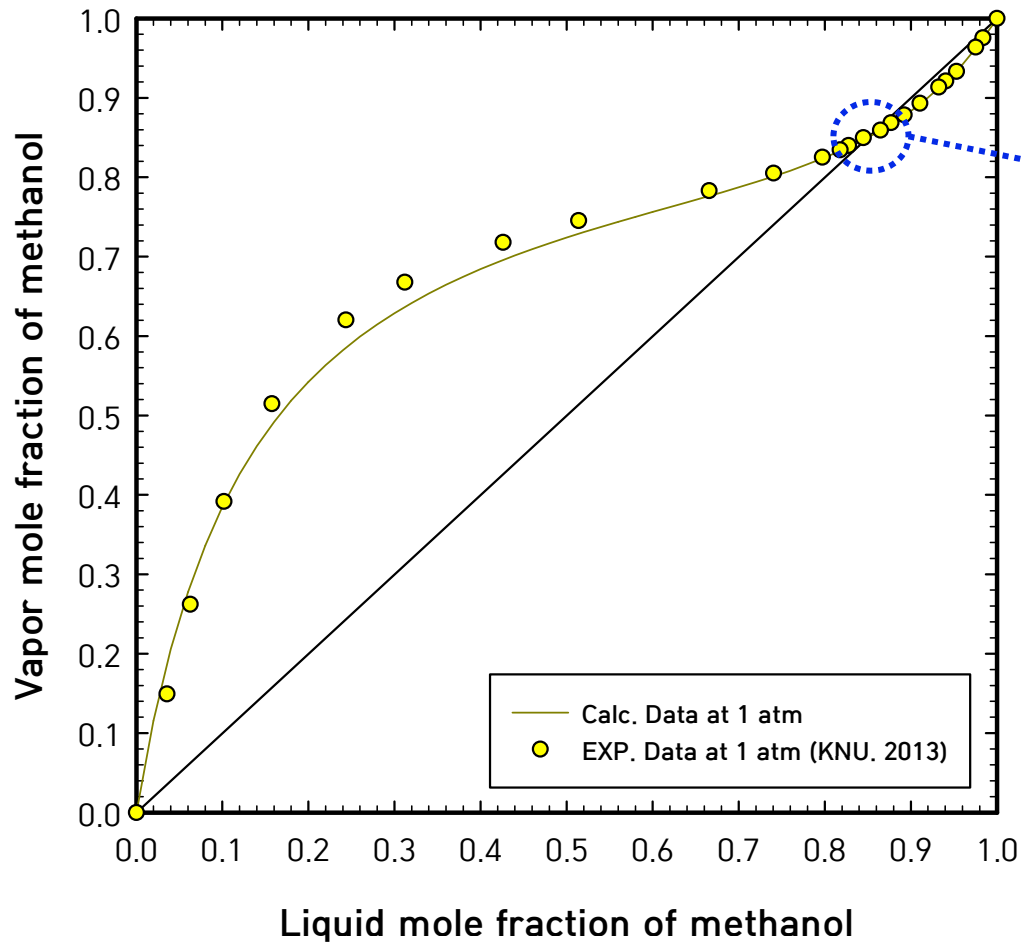

	실험값	Regression값
공비조성	0.85	0.8599
공비온도	63.62°C	63.45°C

i : methanol, j : DMC

Thermodynamic Model	Binary parameter	
NRTL-RK	$a_{ij}$	-7.6996
	$a_{ji}$	4.4904
	$b_{ij}$	3026.1
	$b_{ji}$	-1464.2
	$\alpha_{ij}$	0.3

# NRTL Parameters regression (저압 : 30 kPa)

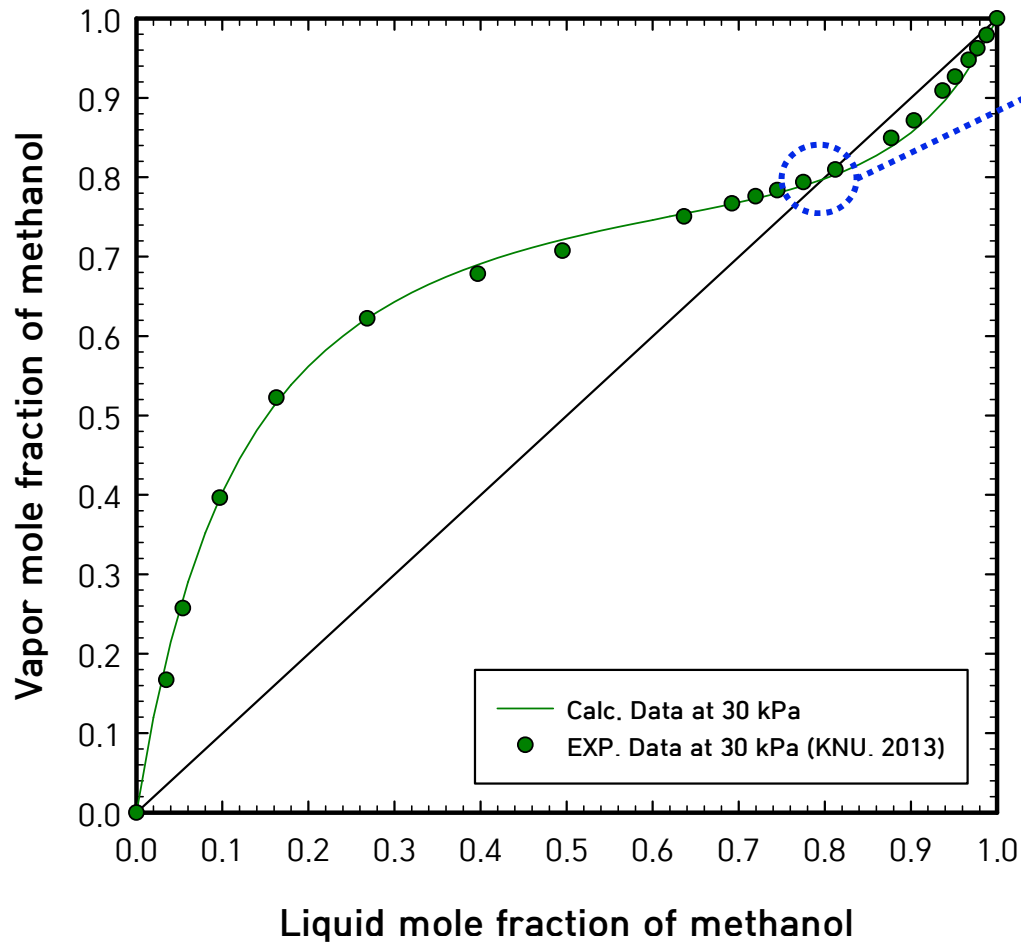

	실험값	Regression값
공비조성	0.81	0.7969
공비온도	35.11°C	34.71°C

i : methanol, j : DMC

Thermodynamic Model	Binary parameter	
NRTL-RK	a <sub>ij</sub>	-11.844
	a <sub>ji</sub>	4.9493
	b <sub>ij</sub>	4155.7
	b <sub>ji</sub>	-1502.7
	$\alpha_{ij}$	0.3
	$\beta_{ij}$	-0.000229

# NRTL Parameters regression (고압 : 10 atm)

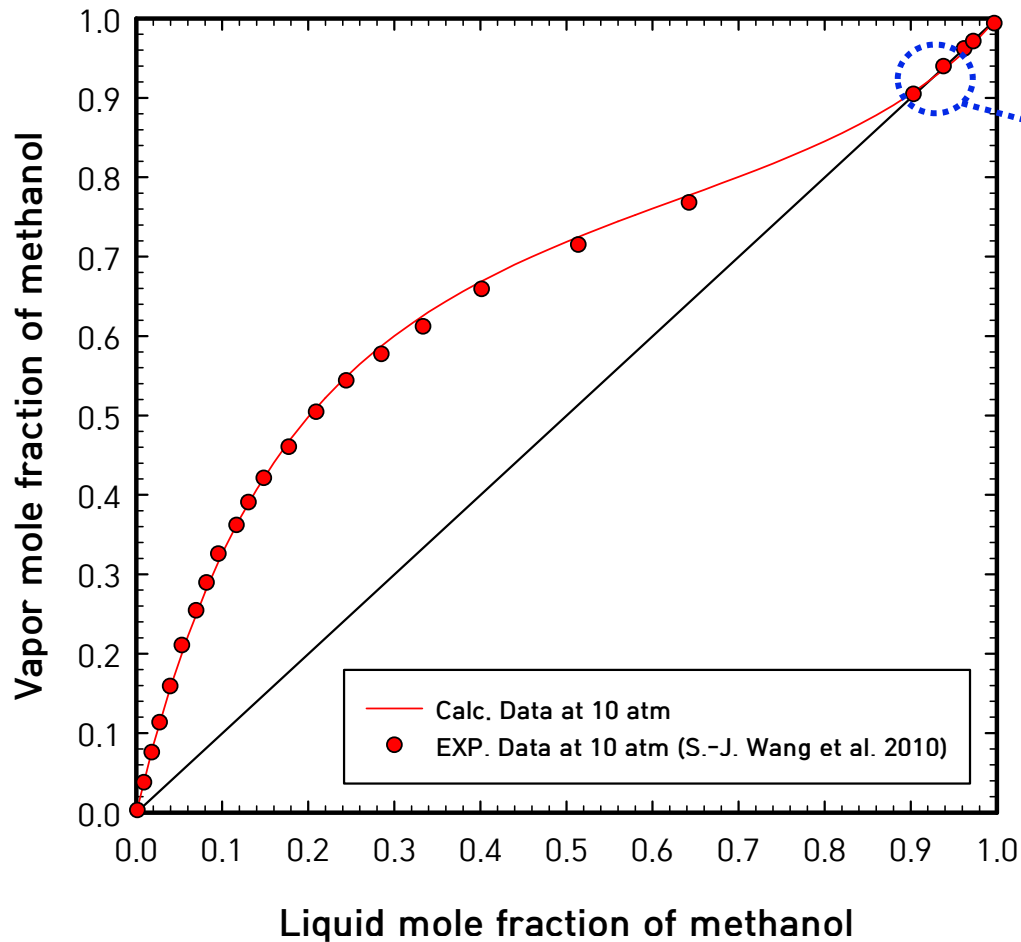

	실험값	Regression값
공비조성	0.9621	0.9206
공비온도	137.09°C	136.85°C

i : methanol, j : DMC

Thermodynamic Model	Binary parameter	
NRTL-RK	$a_{ij}$	2.0
	$a_{ji}$	-1.9085
	$b_{ij}$	-372.89
	$b_{ji}$	784.54
	$\alpha_{ij}$	0.3

# NRTL Parameters regression (고압 : 10 atm)

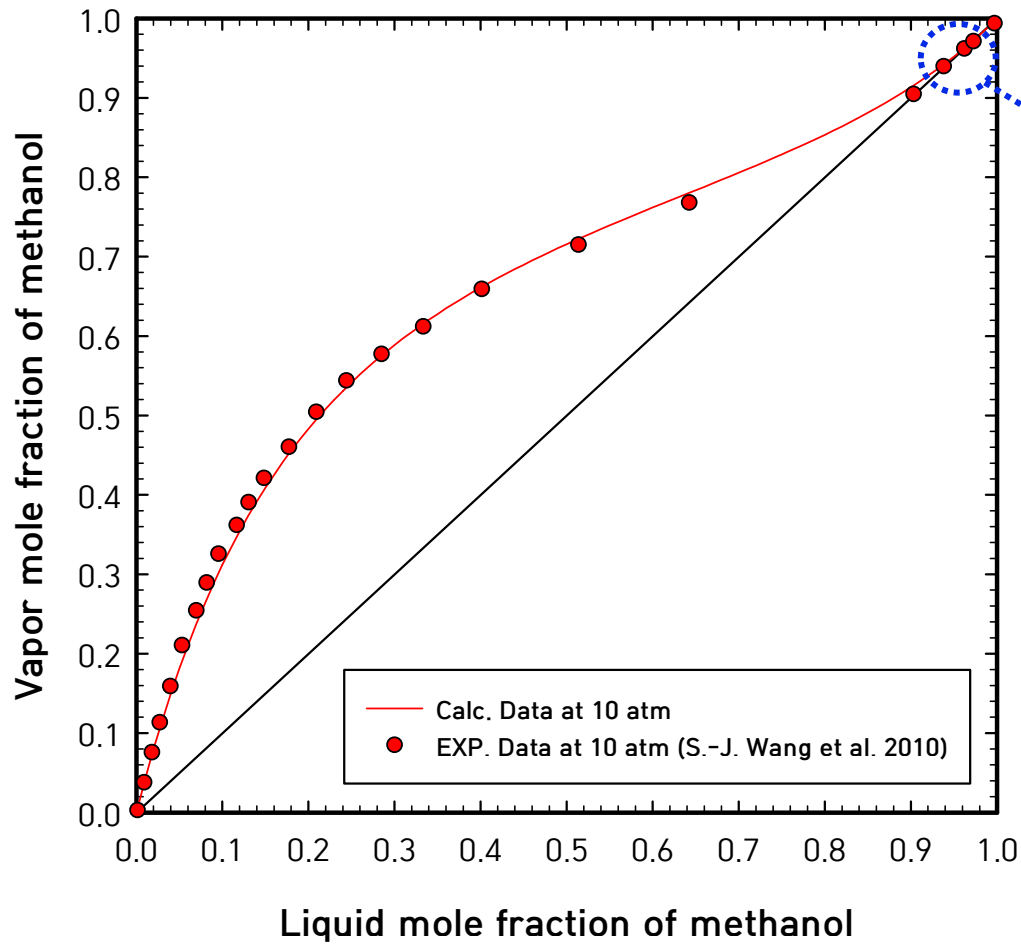

	실험값	Regression값
공비조성	0.9621	0.9610
공비온도	137.09°C	137.18°C

i : methanol, j : DMC

Thermodynamic Model	Binary parameter	
NRTL-RK	$a_{ij}$	1.9009
	$a_{ji}$	-1.9085
	$b_{ij}$	-392.89
	$b_{ji}$	784.54
	$\alpha_{ij}$	0.3

# Design of PSD: (Paper) using Aspen Plus

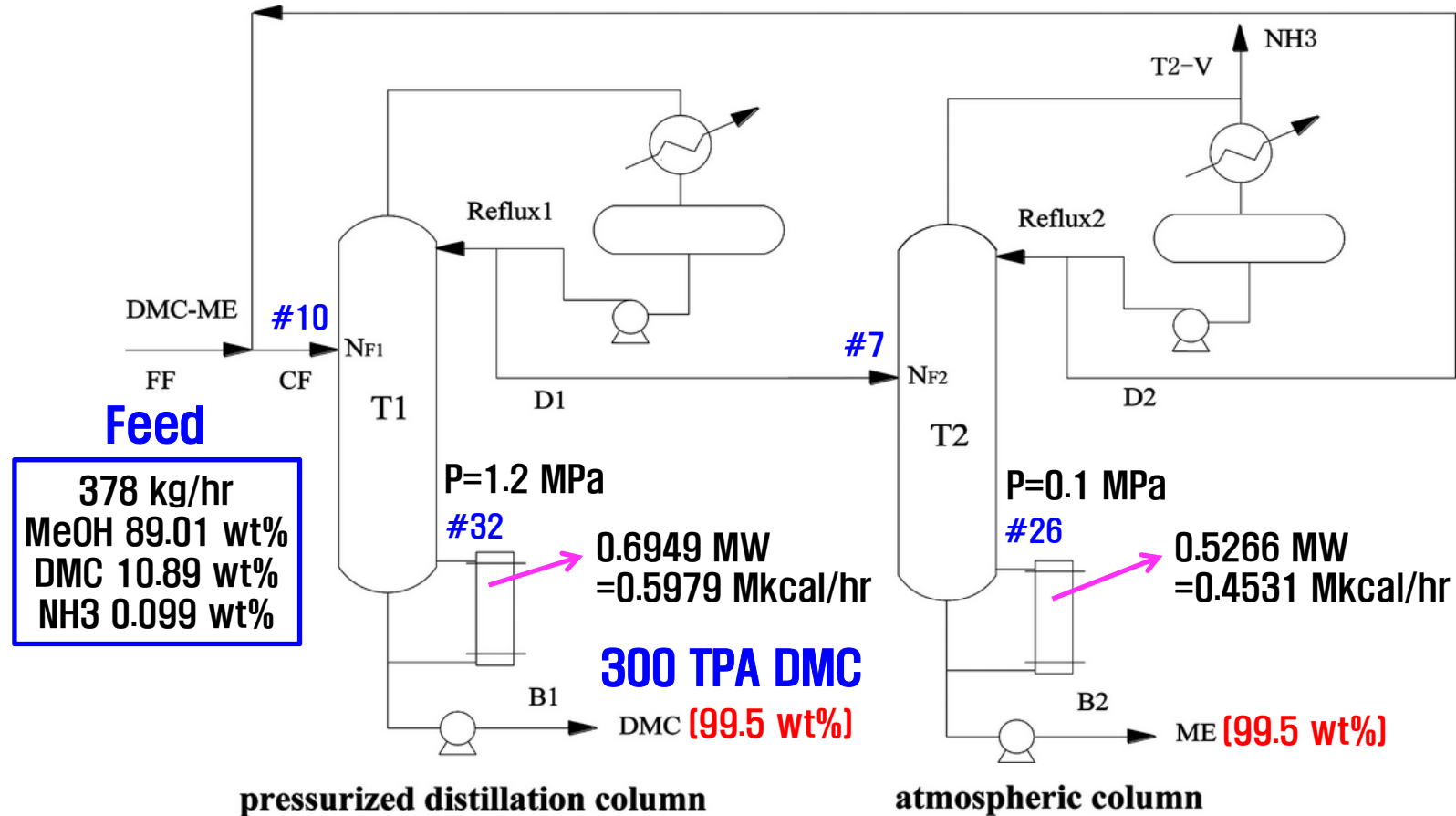

Design and Control of Dimethyl Carbonate-Methanol Separation via Pressure-Swing Distillation

Hong-Mei Wei, Feng Wang, Jun-Liang Zhang, Bo Liao, Ning Zhao, Fu-kui Xiao, Wei Wei, and Yu-Han Sun

# 압력에 따른 Regression 결과

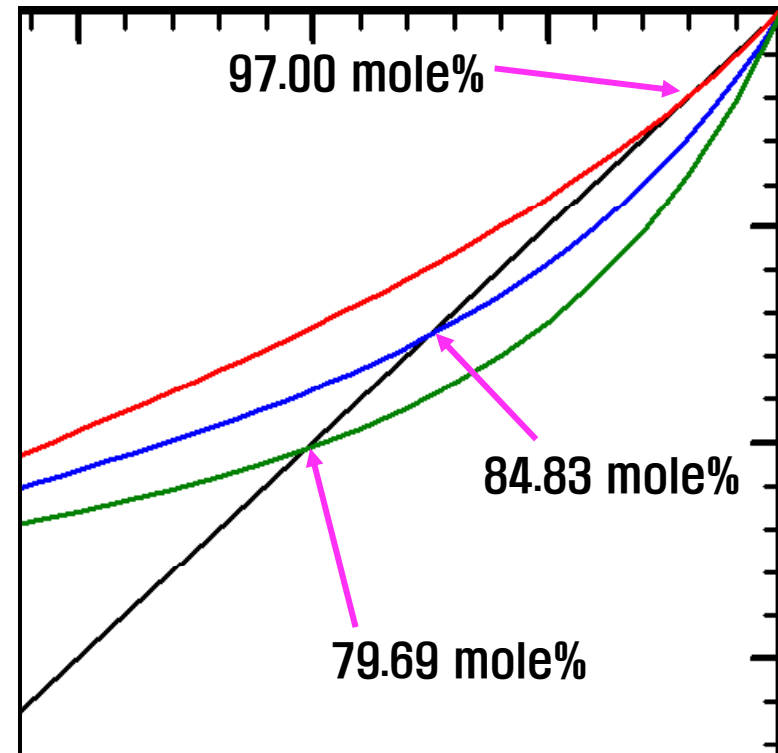
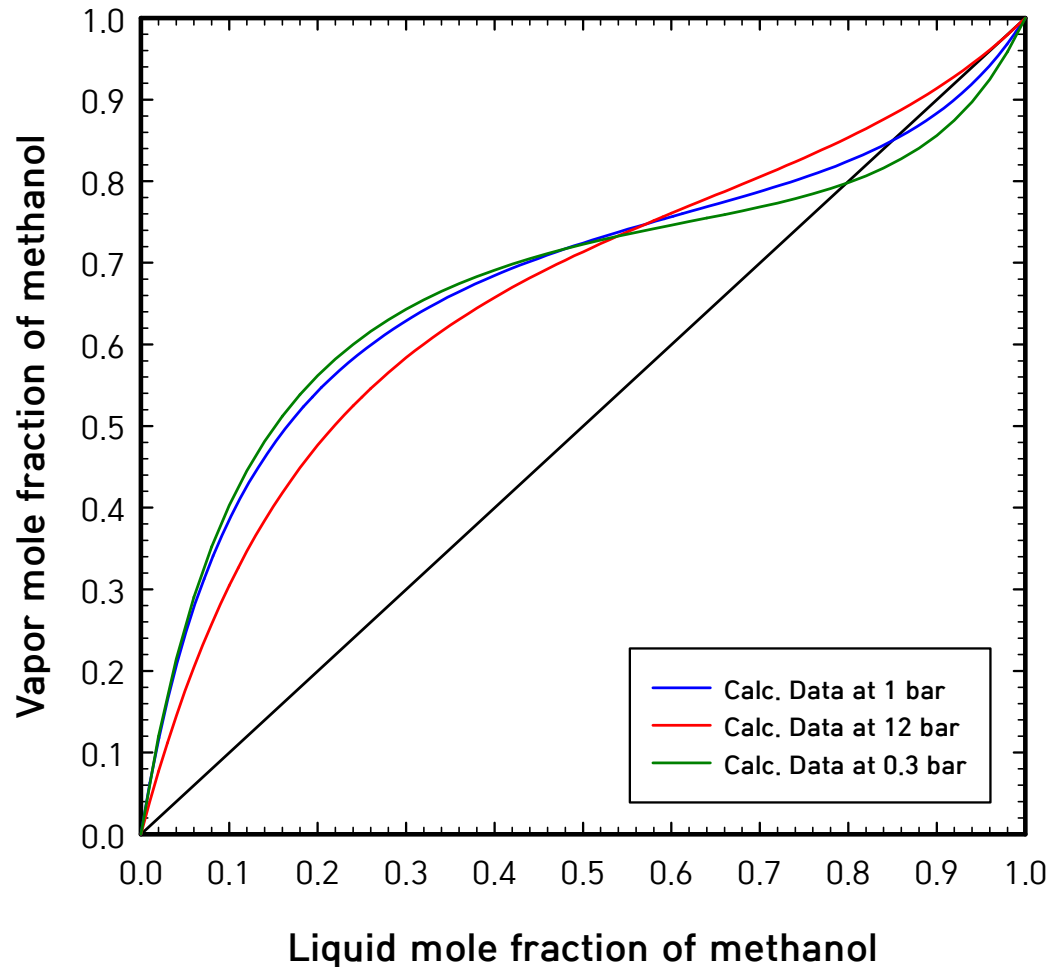



# PSD 모델링 : High(12 bar)-Low(1 bar) 배열

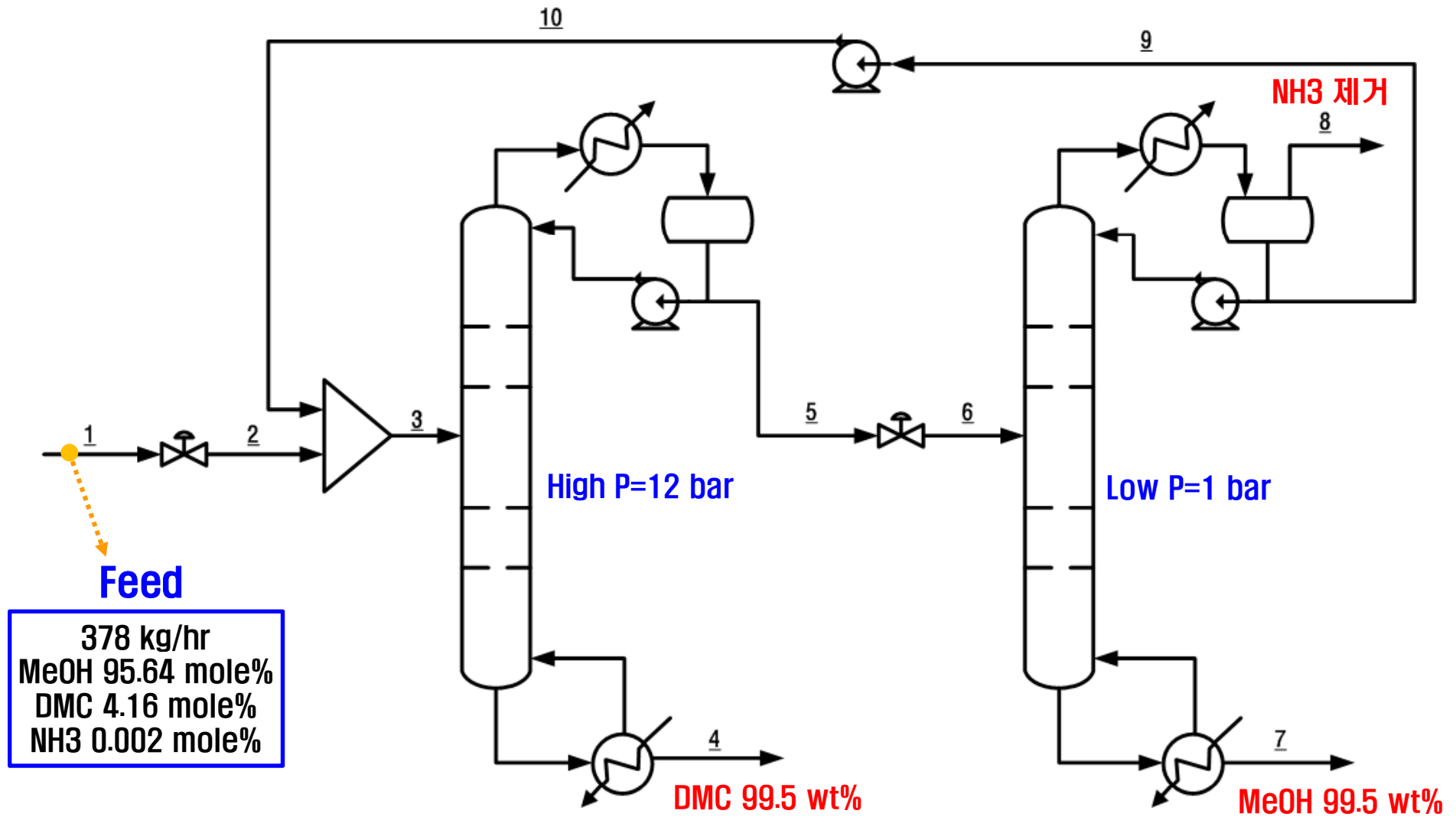

# 공정 최적화 (Column spec. MeOH 조성)

High pressure column optimization

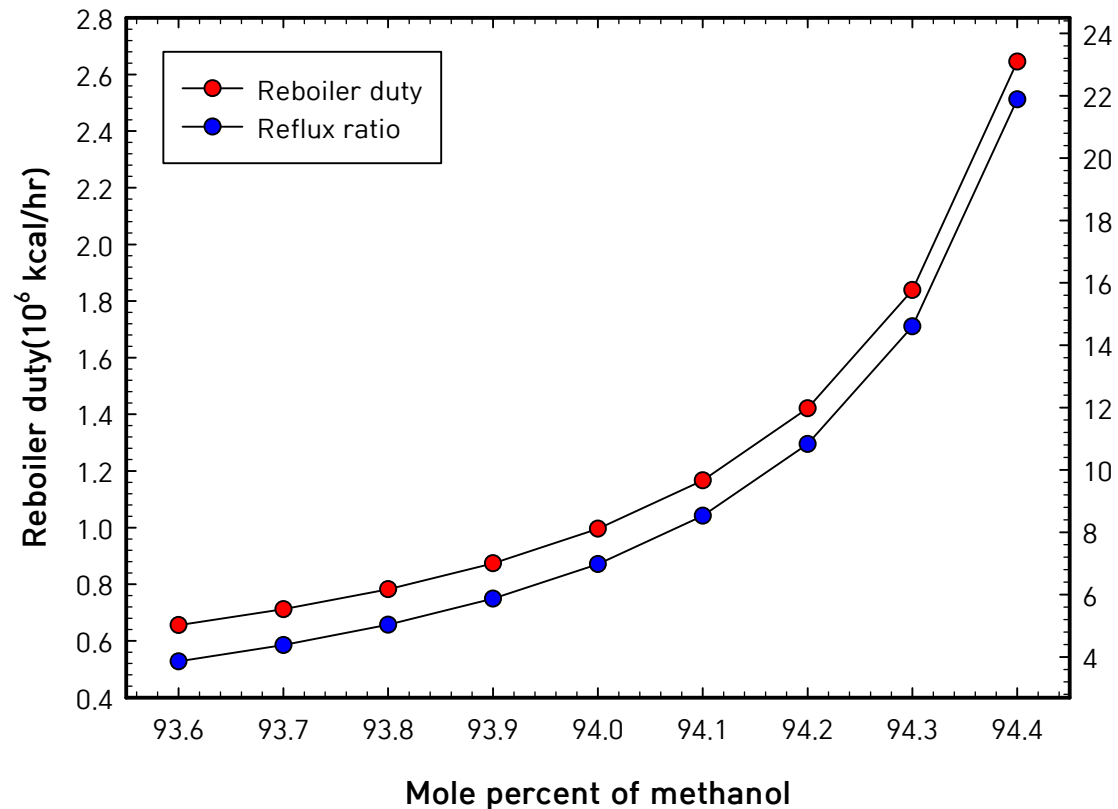

High pressure column optimization

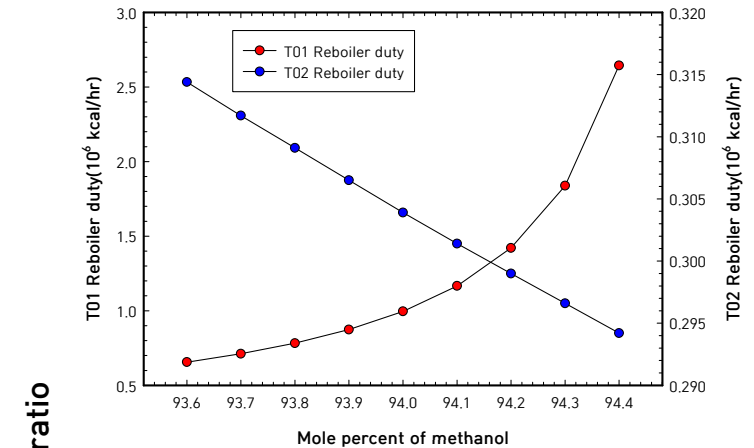

High pressure column optimization

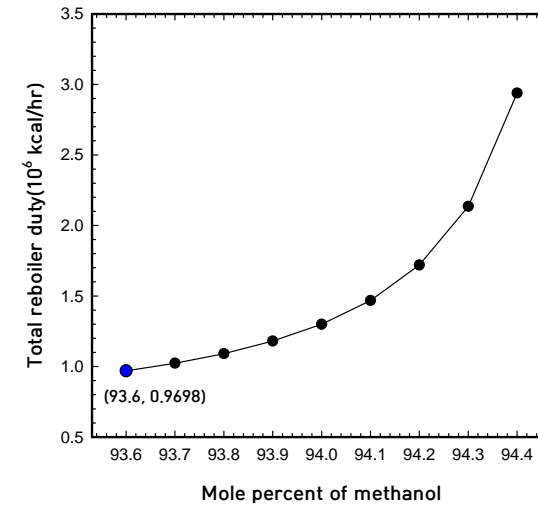

# 공정 최적화 (Column spec. MeOH 조성)

Low pressure column optimization

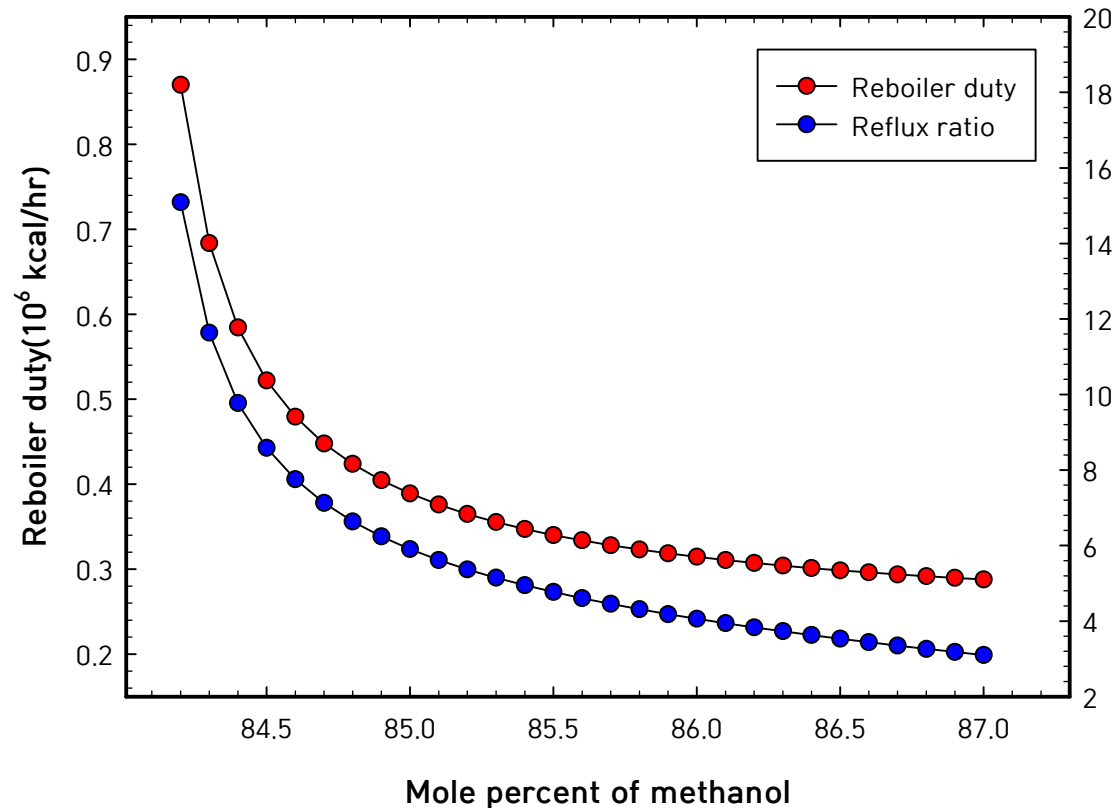

Low pressure column optimization

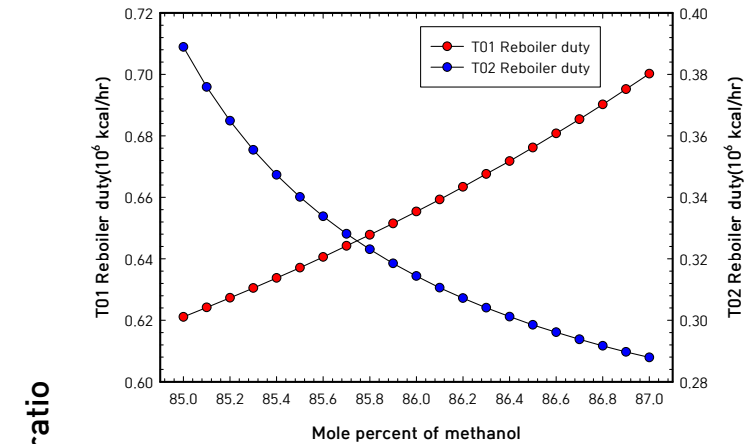

Low pressure column optimization

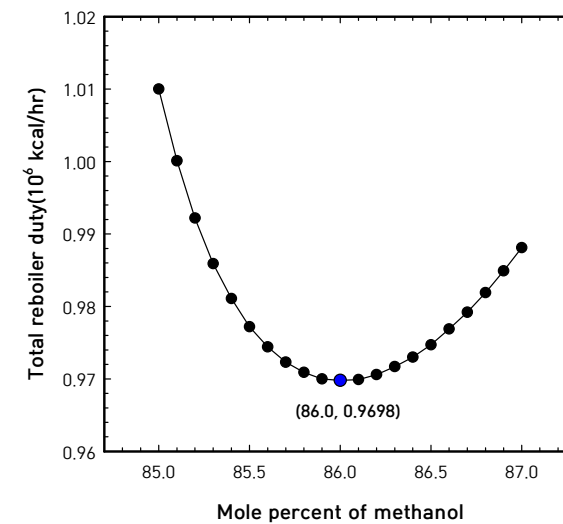

# 공정 최적화 (이론단수)

High pressure column optimization

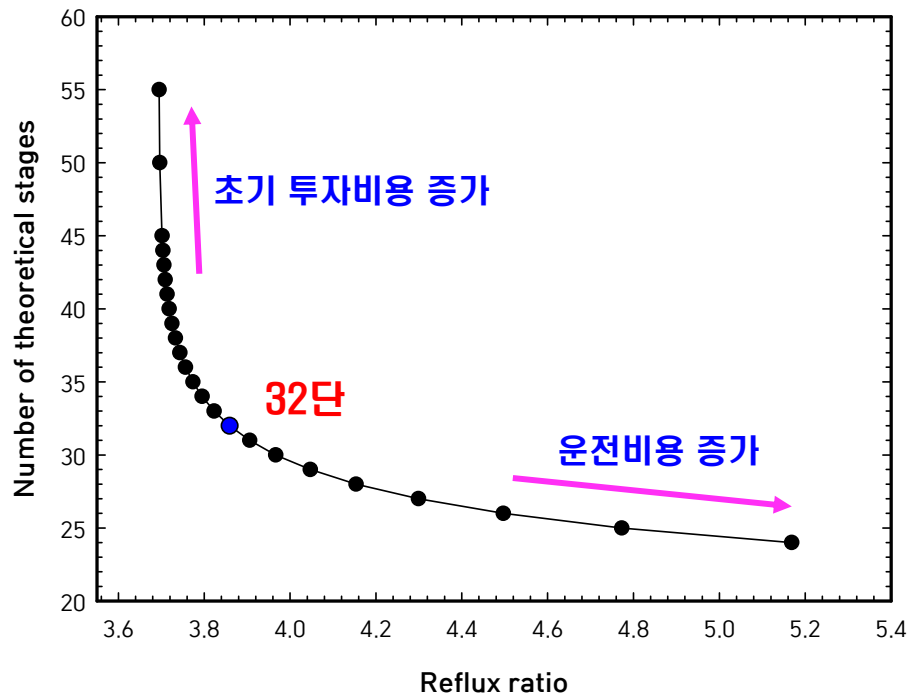

Low pressure column optimization

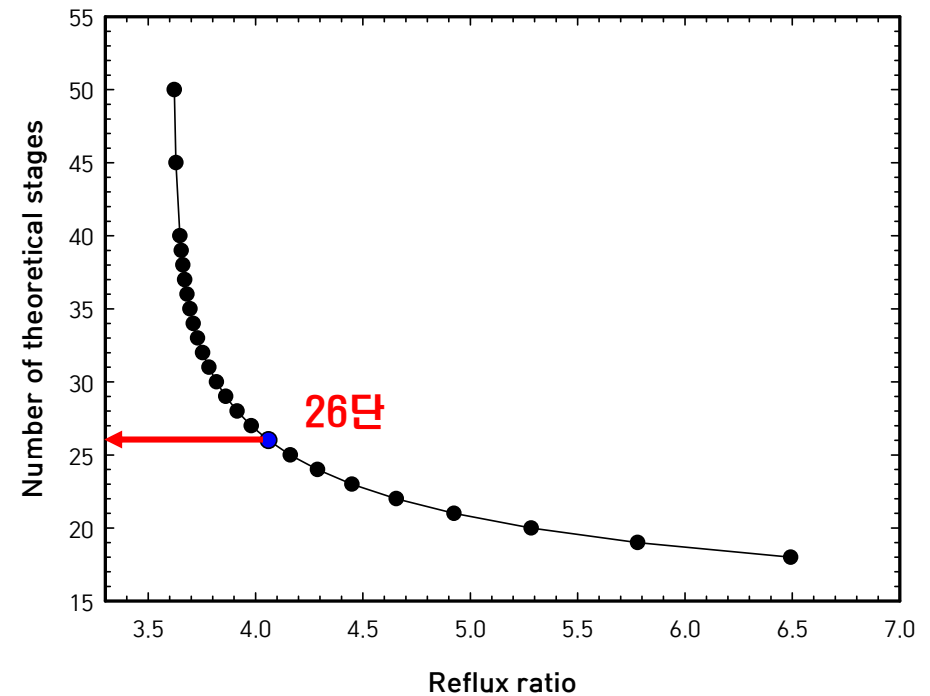

# 공정 최적화 (Feed 유입단)

High pressure column optimization

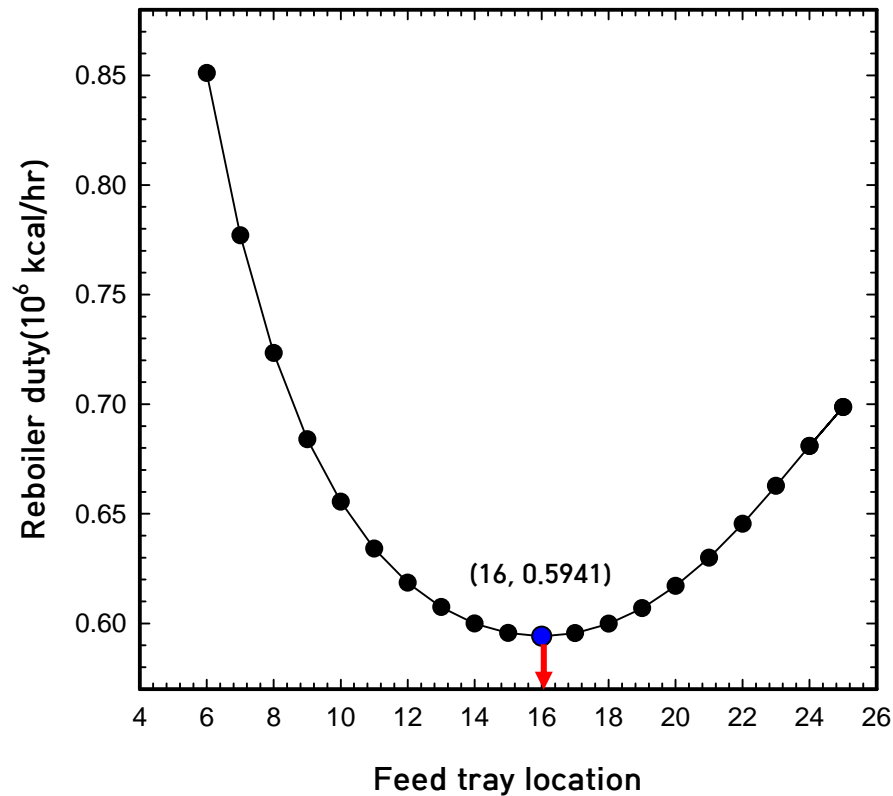

Low pressure column optimization

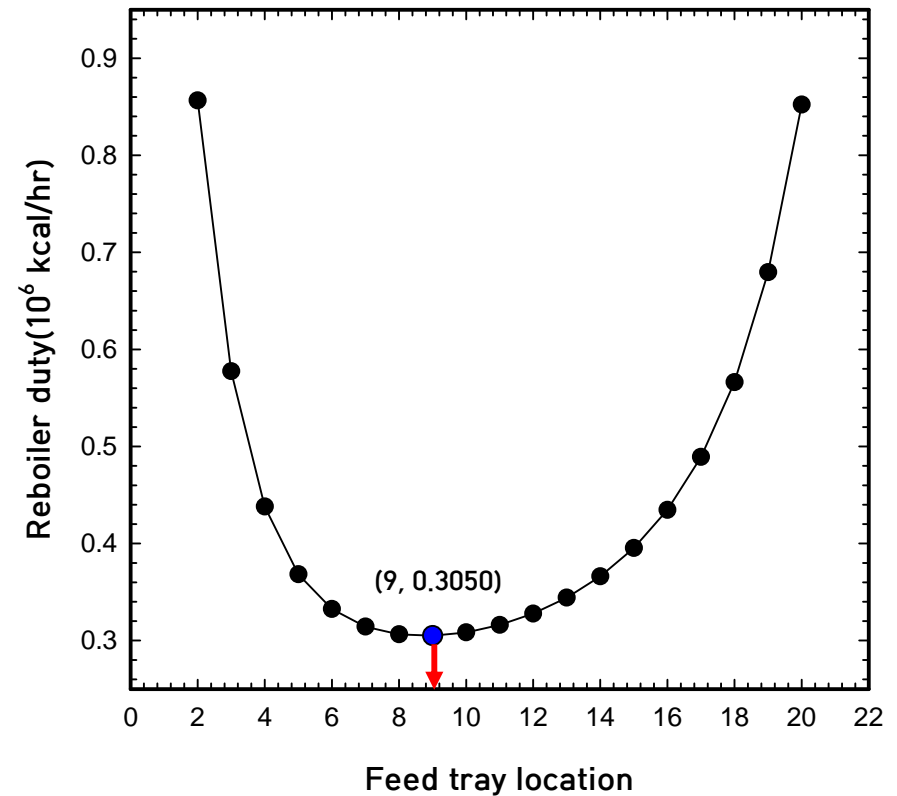

# High-Low 배열 PSD 공정 최적화 결과

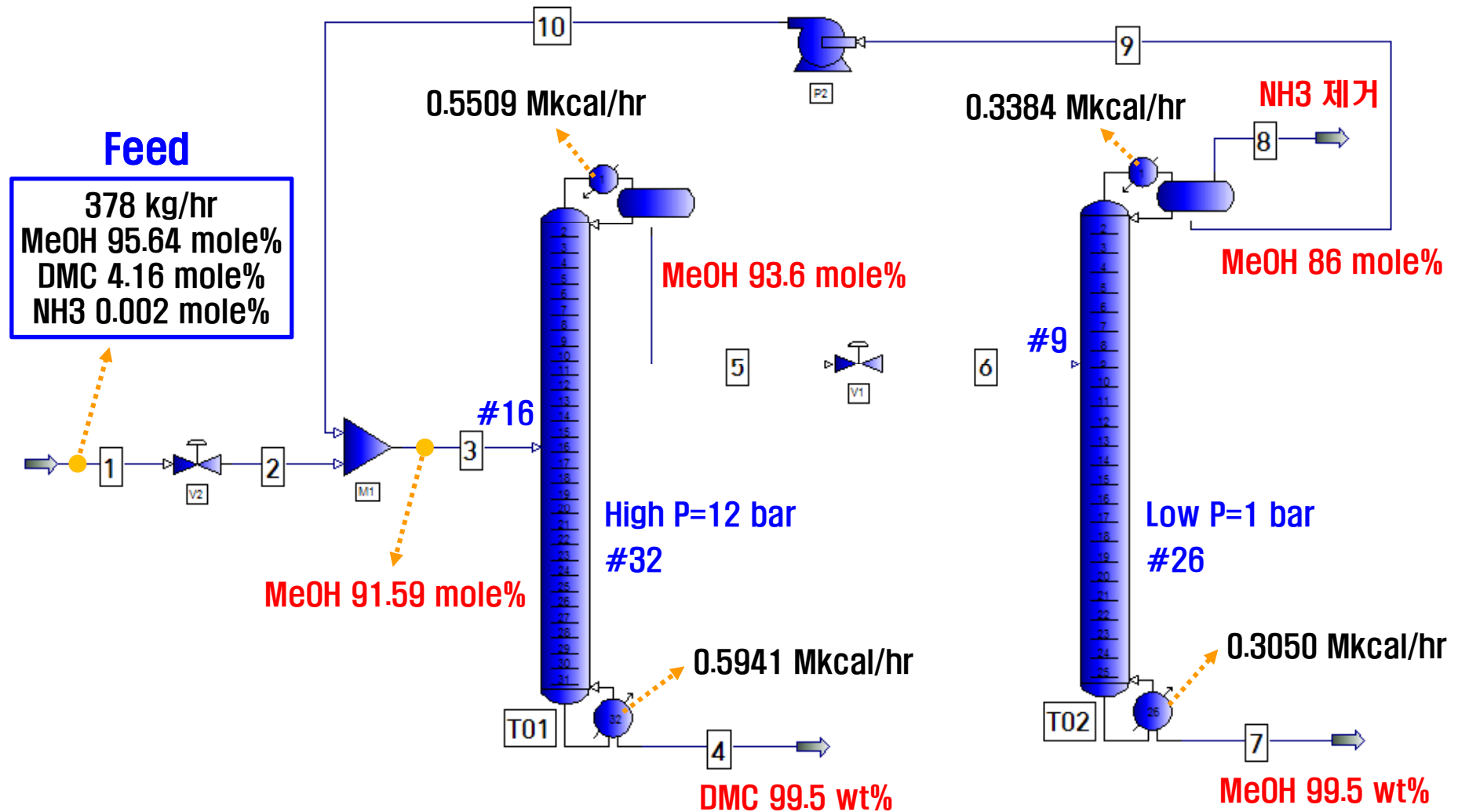

# 공정모사 결과 비교

## Reference by H.M. Wei et al.

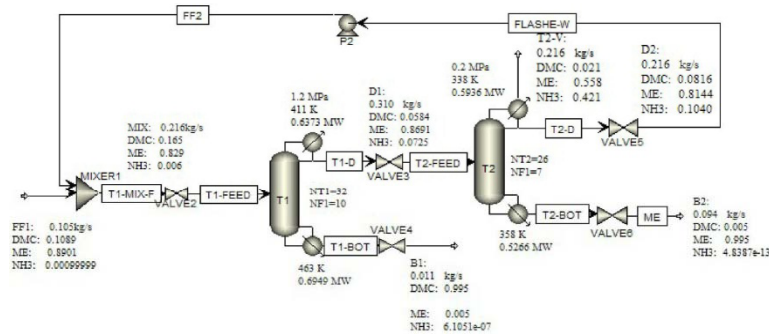

High P (12 bar)      Low P (1 bar)

$N_{stage}$	32	26
Feed tray location	10	7
Product at Bottom	99.5 wt% DMC	99.5 wt% MeOH
Reboiler duty (Mkcal/hr)	0.5979	0.4531
Total duty (Mkcal/hr)	<b>1.0510</b>	

## High-Low configuration

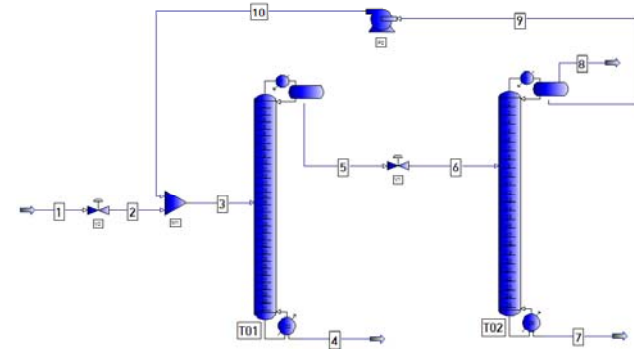

High P (12 bar)      Low P (1 bar)

$N_{stage}$	32	26
Feed tray location	16	9
Product at Bottom	99.5 wt% DMC	99.5 wt% MeOH
Reboiler duty (Mkcal/hr)	0.5941	0.3050
Total duty (Mkcal/hr)	<b>0.8991</b>	

Reference 보다 PRO/II를 이용한 High-Low 배열 최적화 시 14.4% 총 duty 감소 효과

# PSD 모델링 : Low(1 bar)-High(12 bar) 배열

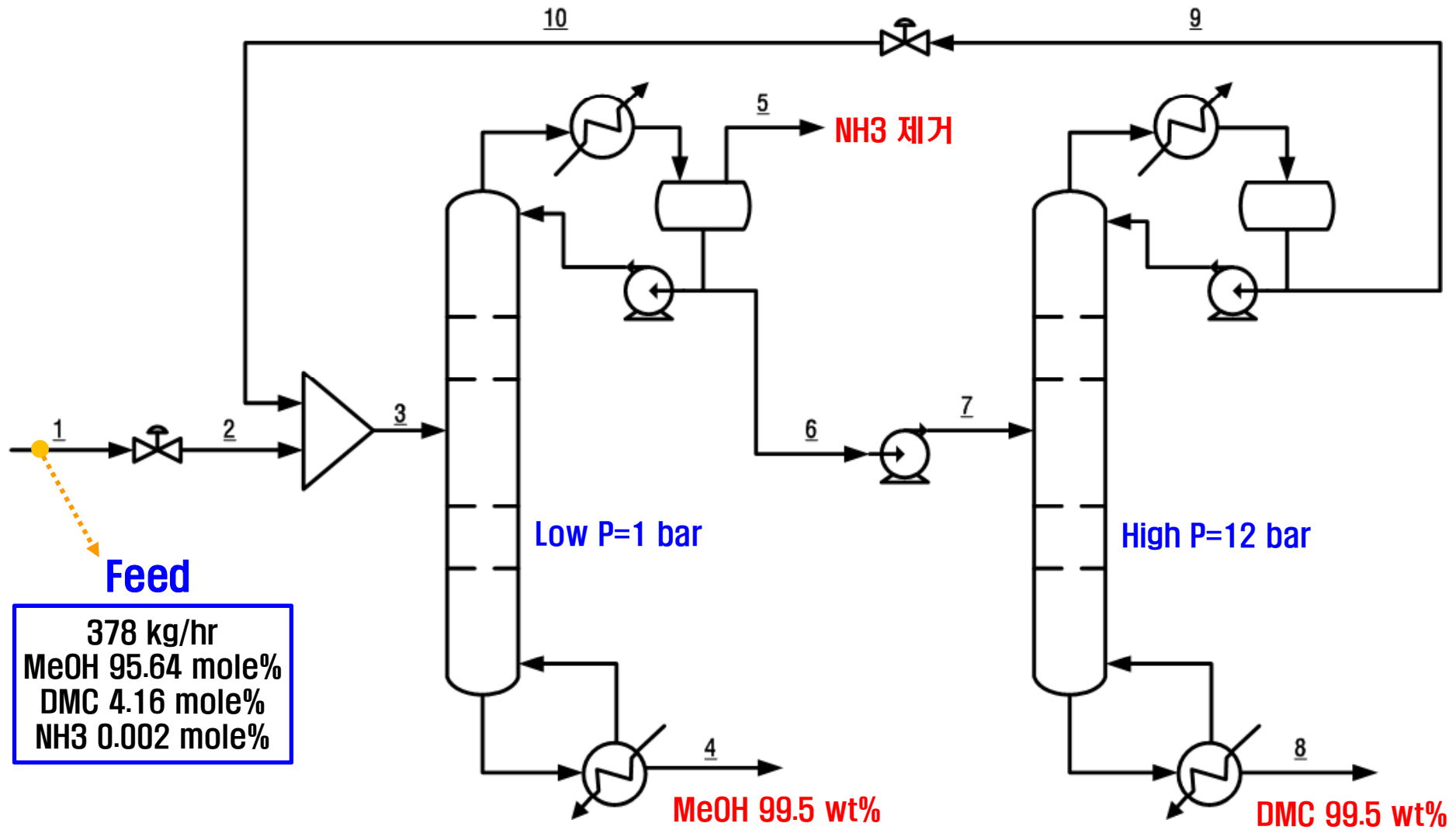



# 공정 최적화 (Column spec. MeOH 조성)

Low pressure column optimization

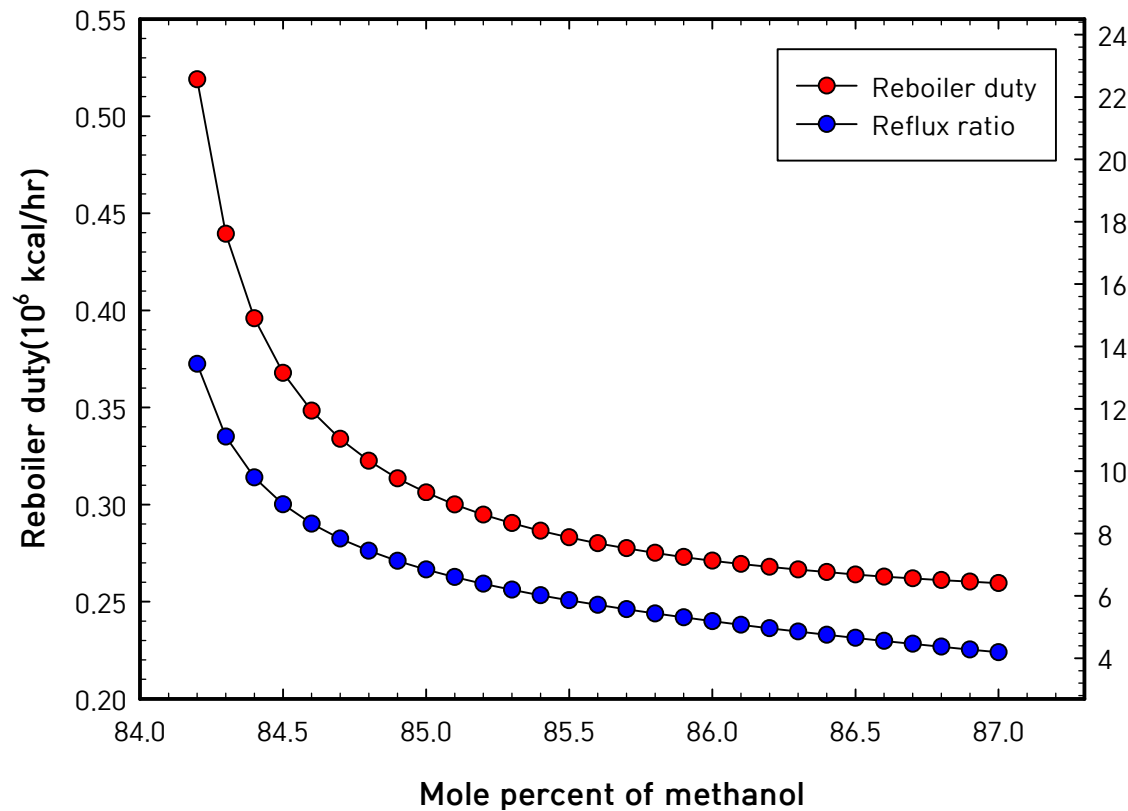

Low pressure column optimization

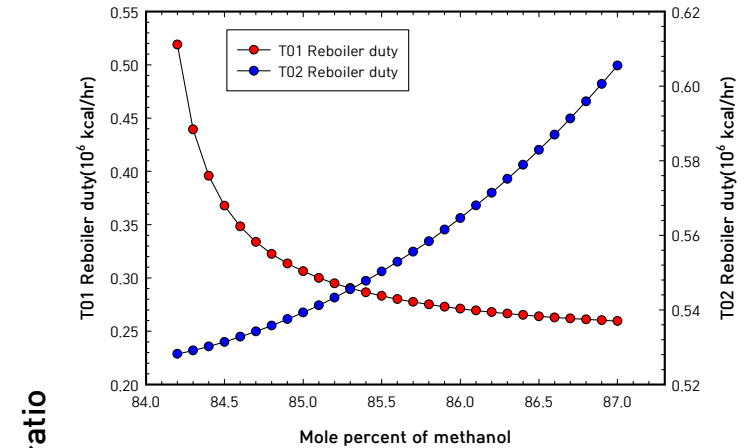

Low pressure column optimization

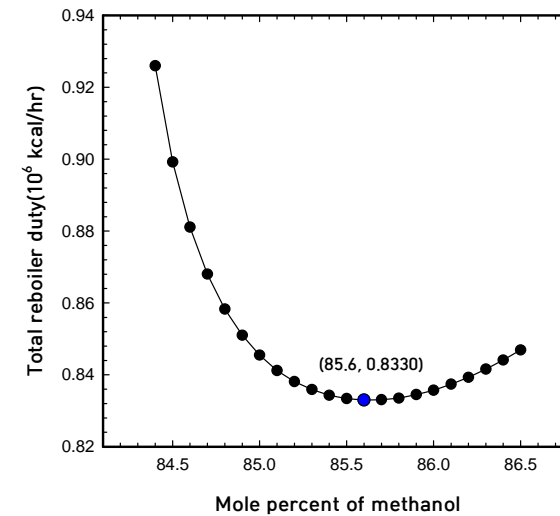

# 공정 최적화 (Column spec. MeOH 조성)

High pressure column optimization

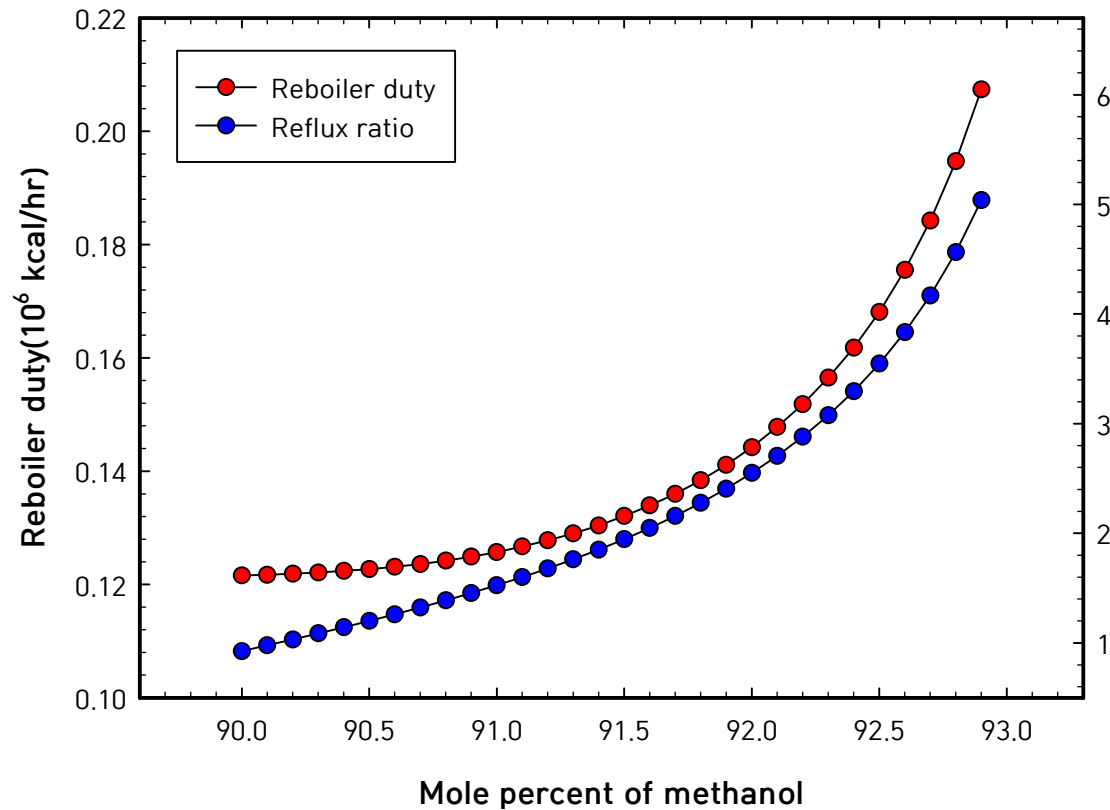

High pressure column optimization

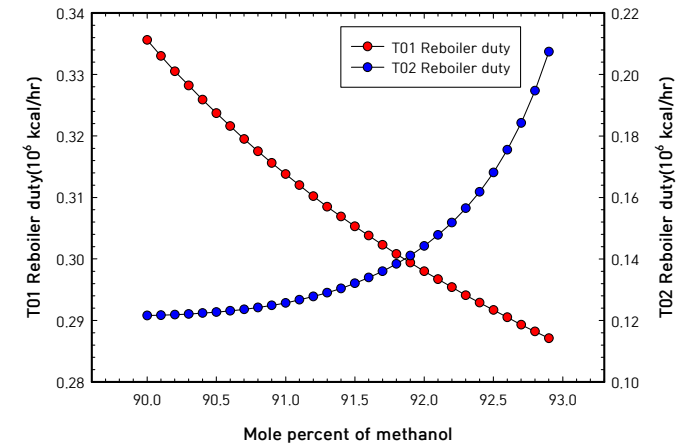

High pressure column optimization

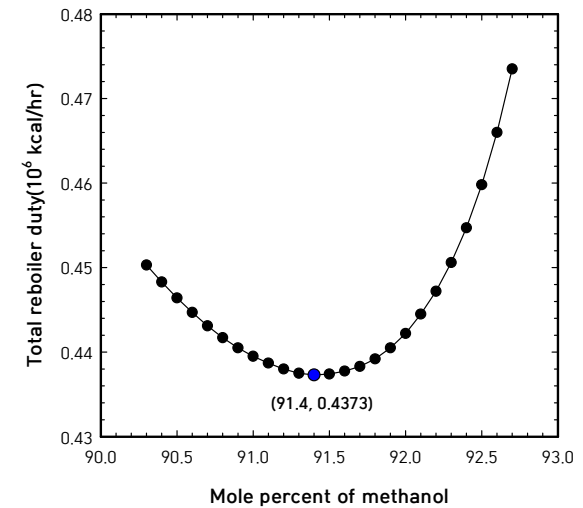

# 공정 최적화 (이론단수)

Low pressure column optimization

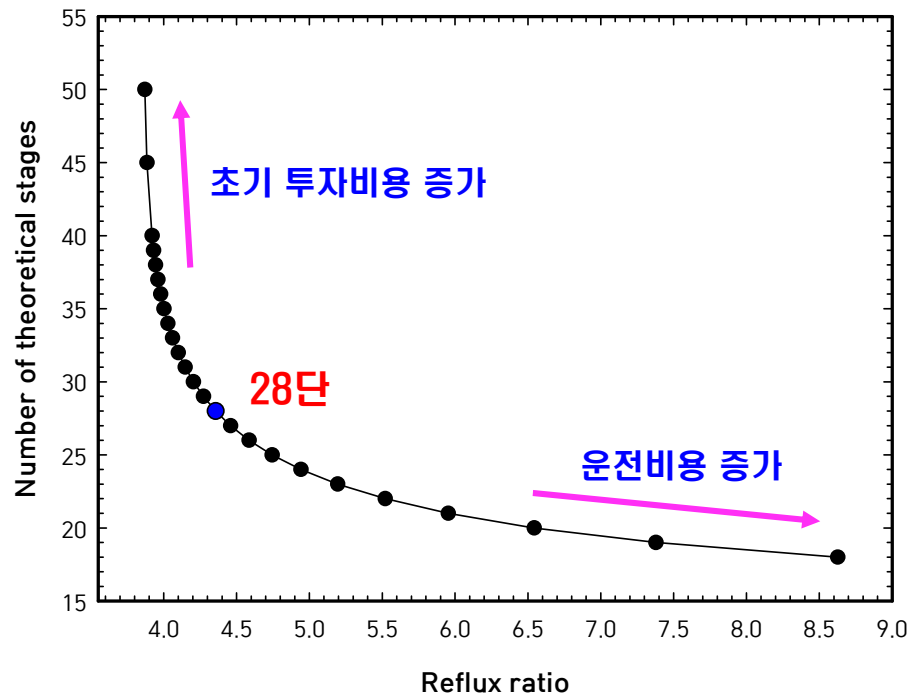

High pressure column optimization

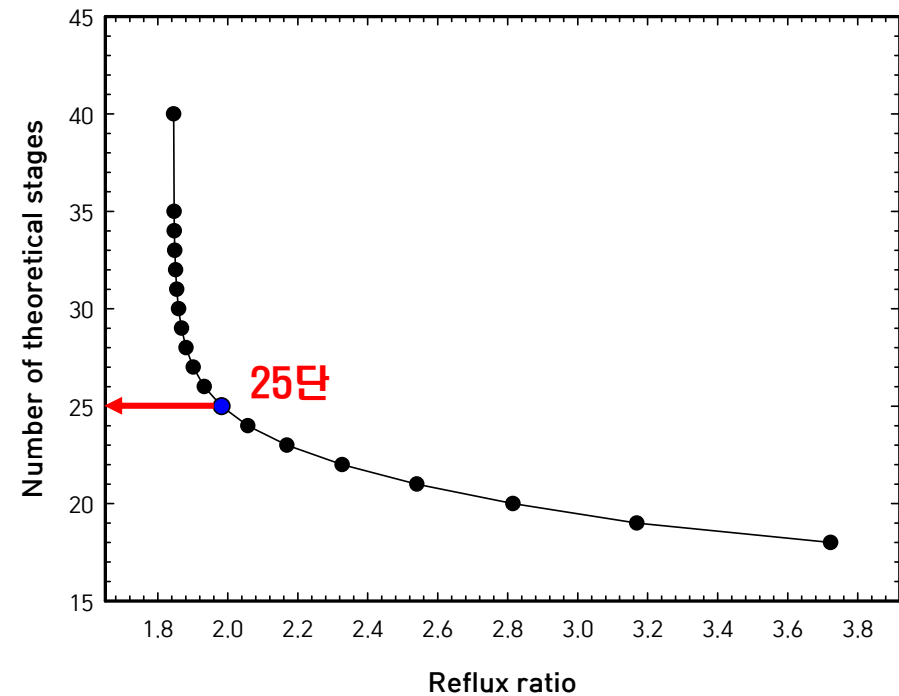

# 공정 최적화 (Feed 유입단)

Low pressure column optimization

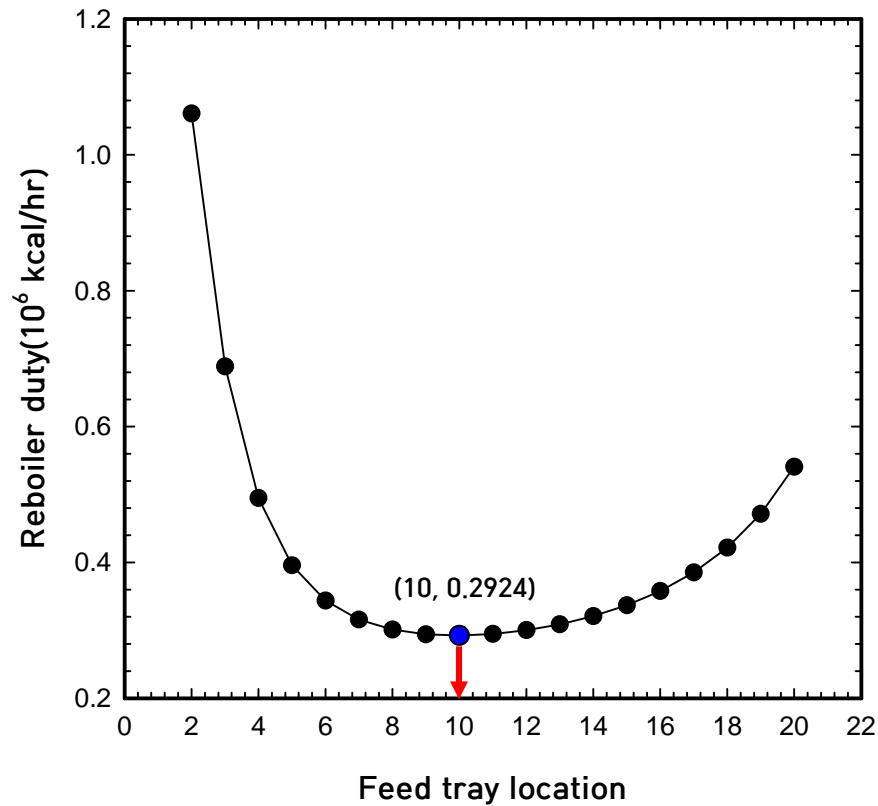

High pressure column optimization

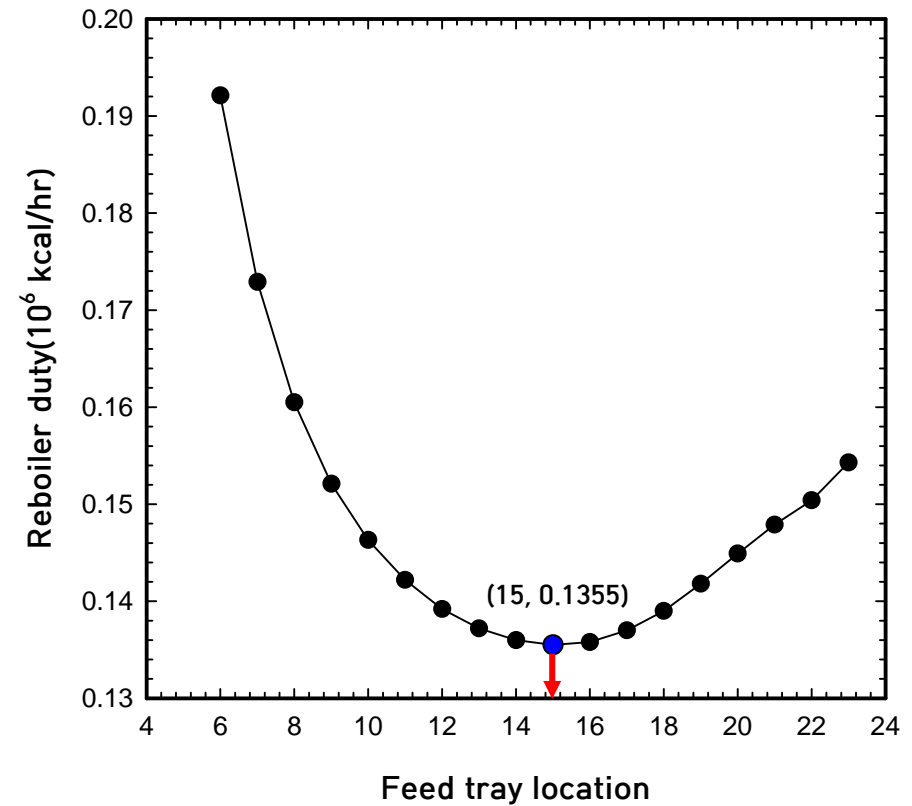

# Low-High 배열 PSD 공정 최적화 결과

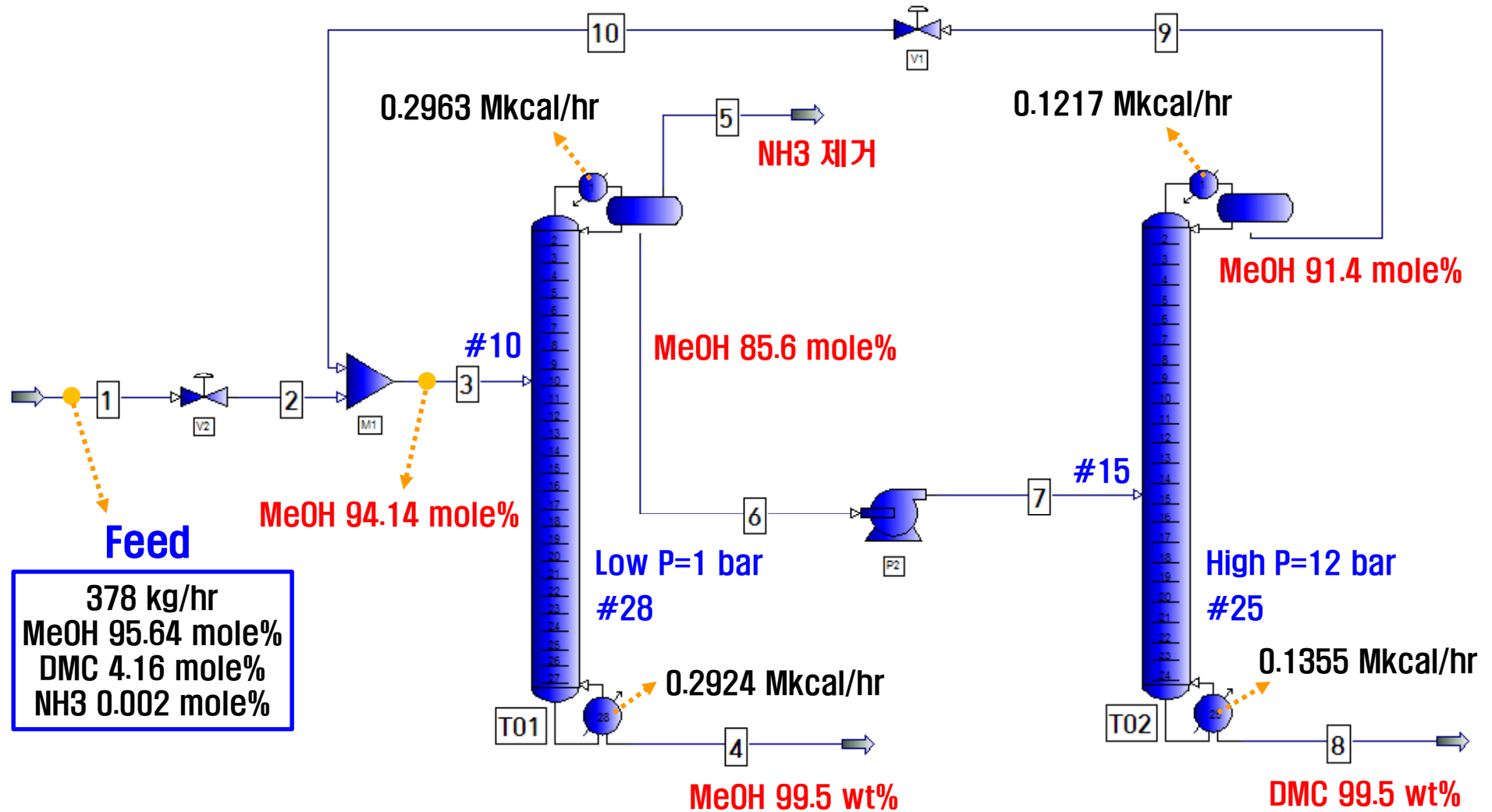

# Heat integration 적용 (Low-High 배열)

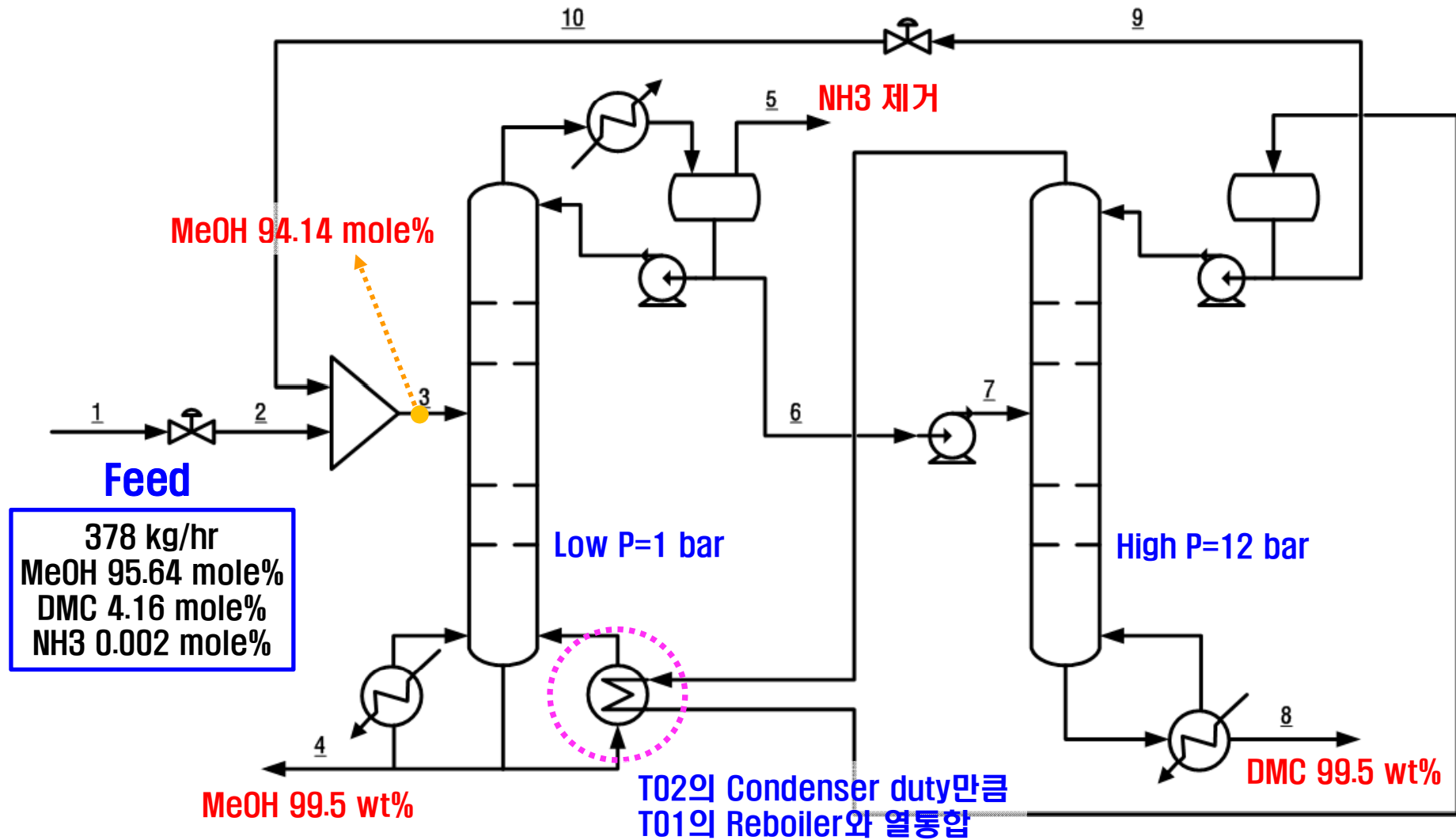

# 공정모사 결과 비교

## High-Low configuration

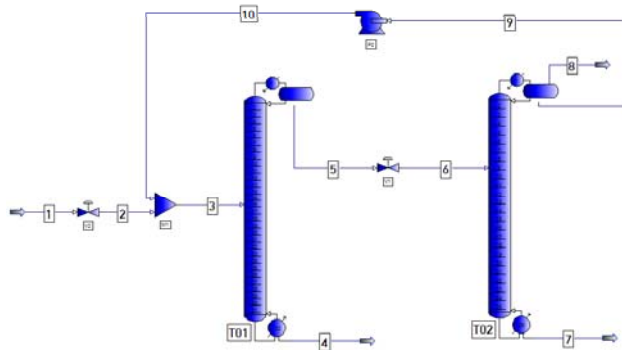

High P (12 bar)      Low P (1 bar)

MeOH at Top	93.6 mole%	86.0 mole%
Product at Bottom	99.5 wt% DMC	99.5 wt% MeOH
Reboiler duty (Mkcal/hr)	0.5941	0.3050
Total duty (Mkcal/hr)	0.8991	

## Low-High configuration

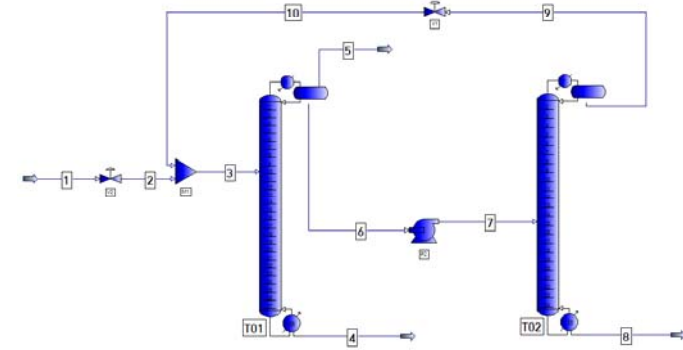

Low P (1 bar)      High P (12 bar)

MeOH at Top	85.6 mole%	91.4 mole%
Product at Bottom	99.5 wt% DMC	99.5 wt% MeOH
Reboiler duty (Mkcal/hr)	0.2924	0.1355
Total duty (Mkcal/hr)	0.4279	

High-Low 배열보다 Low-High 배열이 52.4% 총 duty 감소 효과  
Heat integration 적용 시, 65.9% 총 duty 감소 효과

**0.3062 Mkcal/hr**

---

감사합니다.